

# Quick Start Guide

## *GV-IP Camera*



Before attempting to connect or operate this product, please read these instructions carefully and save this manual for future use.

IC-QG-AP-EN



© 2016 GeoVision, Inc. All rights reserved.

Under the copyright laws, this manual may not be copied, in whole or in part, without the written consent of GeoVision.

Every effort has been made to ensure that the information in this manual is accurate. GeoVision, Inc. makes no expressed or implied warranty of any kind and assumes no responsibility for errors or omissions. No liability is assumed for incidental or consequential damages arising from the use of the information or products contained herein. Features and specifications are subject to change without notice. **Note that memory card slot (local storage) is not supported for Argentina.**

GeoVision, Inc.  
9F, No. 246, Sec. 1, Neihu Rd.,  
Neihu District, Taipei, Taiwan  
Tel: +886-2-8797-8377  
Fax: +886-2-8797-8335  
<http://www.geovision.com.tw>

Trademarks used in this manual: *GeoVision*, the *GeoVision* logo and *GV* series products are trademarks of GeoVision, Inc. *Windows* is the registered trademarks of Microsoft Corporation.

April 2016

# Contents

Introduction .....	viii
Options .....	xxi
Note for Connecting to GV-System / GV-VMS .....	xxiii
Note for Recording.....	xxiv
Note for Adjusting Focus and Zoom .....	xxv
Note for Installing Camera Outdoor .....	xxvi
Note for Closing the Bullet Camera Cover.....	xxviii
Note for Bullet Waterproof Failures.....	xxix
Note for USB Storage and WiFi Adapter .....	xxx
Note for Silica Gel Bags .....	xxx
<b>1. Box Camera .....</b>	<b>1</b>
1.1 Packing List.....	1
1.2 Overview .....	2
GV-BX1200 Series / 1500 Series / 2400 Series / 2500 Series / 2600 / 3400 Series / 5300 Series / 12201.....	2
1.3 Accessory Installation.....	5
1.3.1 C-Mount Lenses.....	5
1.3.2 Infrared Illuminators (Optional) .....	6
1.4 Connecting the Camera.....	7
GV-BX1200 Series / 1500 Series / 2400 Series / 2500 Series / 2600 / 3400 Series / 5300 Series/ 12201.....	7
<b>2. Ultra Box Camera.....</b>	<b>9</b>
2.1 Packing List.....	9
2.2 Overview .....	10
2.3 Installation .....	11
2.4 Connecting the Camera.....	13
<b>3. Target Box Camera .....</b>	<b>14</b>
3.1 Packing List.....	14

3.2 Overview .....	15
3.3 Installation .....	16
3.4 Connecting the Camera.....	18
<b>4. IR Arctic Box Camera .....</b>	<b>19</b>
4.1 Packing List.....	19
4.2 Overview .....	21
4.3 Installation .....	23
4.4 Connecting the Camera.....	28
<b>5. Mini Fixed Dome &amp; Mini Fixed Rugged Dome .....</b>	<b>32</b>
5.1 Packing List.....	32
5.2 Overview .....	34
GV-MFD1501 Series / 2401 Series / 2501 Series / 3401 Series / 5301 Series.....	34
GV-MDR .....	36
5.3 Installation.....	39
GV-MFD Series.....	39
GV-MDR Series .....	41
5.4 Connecting the Camera.....	45
5.4.1 Wire Definition.....	45
5.4.2 Power and Network Connection .....	45
5.4.3 Vehicle Installation .....	46
<b>6. Target Mini Fixed Dome.....</b>	<b>47</b>
6.1 Packing List.....	47
6.2 Overview .....	48
6.3 Installation .....	49
6.4 Connecting the Camera.....	51
<b>7. Target Mini Fixed Rugged Dome .....</b>	<b>52</b>
7.1 Packing List.....	52
7.2 Overview .....	54
7.3 Installation .....	55
7.4 Connecting the Camera.....	61



<b>8. Bullet Camera (Part I)</b> .....	<b>62</b>
8.1 Packing List.....	62
8.2 Overview .....	63
8.3 Installation .....	64
8.3.1 Adjusting the Angles .....	66
8.3.2 Adjusting Lens and Inserting a Memory Card .....	69
8.3.3 Inserting the Sun-Shield Cover.....	72
8.4 Connecting the Camera.....	73
8.4.1 Wire Definition.....	73
8.4.2 Connecting the Power Cable.....	75
<b>9. Bullet Camera (Part II)</b> .....	<b>76</b>
9.1 Packing List.....	76
9.2 Overview .....	77
9.3 Installation .....	79
9.4 Connecting the Camera.....	86
<b>10. Bullet Camera (Part III)</b> .....	<b>88</b>
10.1 Packing List.....	88
10.2 Overview .....	89
10.3 Installation .....	90
10.3.1 Adjusting the Angles.....	94
10.3.2 Adjusting Lens.....	96
10.4 Connecting the Camera.....	97
10.4.1 Wire Definition.....	97
10.4.2 Power Connection.....	98
<b>11. Ultra Bullet Camera</b> .....	<b>99</b>
11.1 Packing List.....	99
11.2 Overview .....	100
11.3 Installation .....	102
11.4 Connecting the Camera.....	106
11.4.1 Waterproofing the Cable .....	106
11.4.2 Wire Definition.....	108
11.4.3 Power Connection.....	109

<b>12. Target Bullet Camera (Part I)</b> .....	<b>110</b>
12.1 Packing List.....	110
12.2 Overview .....	111
12.3 Installation .....	113
12.4 Connecting the Camera.....	117
12.4.1 Wire Definition.....	117
12.4.2 Power Connection.....	118
<b>13. Target Bullet Camera (Part II)</b> .....	<b>119</b>
13.1 Packing List.....	119
13.2 Overview .....	121
13.3 Installation .....	122
13.4 Connecting the Camera.....	127
13.4.1 Wire Definition.....	127
13.4.2 Power Connection.....	127
<b>14. Vandal Proof IP Dome (Part I)</b> .....	<b>128</b>
14.1 Packing List.....	128
14.2 Overview .....	130
14.3 Installation .....	132
14.3.1 Hard-Ceiling Mount .....	133
14.3.2 In-Ceiling Mount .....	138
14.4 Connecting the Camera.....	141
14.4.1 Wire Definition.....	141
14.4.2 Connecting the Power Cable.....	143
<b>15. Vandal Proof IP Dome (Part II)</b> .....	<b>144</b>
15.1 Packing List.....	144
15.2 Overview .....	147
15.3 Installation .....	149
15.4 Connecting the Camera.....	159
15.4.1 Connecting the Power Cable.....	159
15.4.2 Connecting the I/O Device.....	160

<b>16. Vandal Proof IP Dome (Part III)</b>	<b>161</b>
16.1 Packing List	161
16.2 Overview	163
16.3 Installation	165
16.4 Connecting the Camera	170
16.4.1 Definition	170
16.4.2 Power Connection	171
<b>17. Target Vandal Proof IP Dome</b>	<b>172</b>
17.1 Packing List	172
17.2 Overview	175
17.3 Installation	177
17.4 Connecting the Camera	186
<b>18. Fixed IP Dome</b>	<b>187</b>
18.1 Packing List	187
18.1.1 Packing List for Hard-Ceiling Mount	187
18.1.2 Packing List for In-Ceiling Mount	188
18.2 Overview	189
18.3 Installation	191
18.3.1 Hard-Ceiling Mount	191
18.3.2 In-Ceiling Mount	195
18.3.3 Wall-Surface Mount	199
18.4 Connecting the Camera	201
<b>19. Target Fixed IP Dome</b>	<b>202</b>
19.1 Packing List	202
19.2 Overview	203
19.3 Installation	205
19.4 Connecting the Camera	207
<b>20. Cube Camera</b>	<b>208</b>
20.1 Packing List	208
20.2 Overview	209
20.3 Installation	210

20.4 Connecting the Camera.....	212
<b>21. Advanced Cube Camera.....</b>	<b>213</b>
21.1 Packing List.....	213
21.2 Overview.....	214
21.3 Installation.....	216
21.4 Connecting the Camera.....	218
<b>22. PT Camera.....</b>	<b>219</b>
22.1 Packing List.....	219
22.2 Overview.....	221
22.3 Installation.....	223
22.3.1 Ceiling Mount.....	223
22.3.2 L-Shaped Wall Mount.....	225
22.4 Connecting the Camera.....	228
<b>23. Pinhole Camera.....</b>	<b>229</b>
23.1 Packing List.....	229
23.2 Overview.....	231
23.3 Installation.....	233
23.4 Connecting the Camera.....	237
<b>24. Accessing the Camera.....</b>	<b>238</b>
24.1 System Requirement.....	238
24.2 Accessing the Live View.....	239
24.2.1 Checking the Dynamic IP Address.....	240
24.2.2 Configuring the IP Address.....	242
24.2.3 Configuring the Wireless Connection.....	244
24.3 Adjusting Image Clarity.....	248
24.3.1 Using Focus Adjustment Cap.....	251
<b>25. The Web Interface.....</b>	<b>252</b>
<b>26. Upgrading System Firmware.....</b>	<b>255</b>

<b>27. Restoring to Default Settings.....</b>	<b>257</b>
27.1 Using the Web Interface .....	257
27.2 Directly on the Camera .....	258
Box Camera .....	258
Ultra Box Camera and Target Box Camera .....	259
Mini Fixed Dome .....	260
Mini Fixed Rugged Dome.....	261
IR Arctic Box Camera.....	261
Target Mini Fixed Target Mini Fixed Rugged Dome .....	262
Bullet Camera .....	263
Ultra Bullet Camera.....	264
Target Bullet Camera .....	264
Vandal Proof IP Dome .....	265
Target Vandal Proof IP Dome .....	266
Fixed IP Dome .....	266
Target Fixed IP Dome.....	267
Cube Camera .....	267
Advanced Cube Camera.....	268
PT Camera .....	268
Pinhole Camera .....	269

## Introduction

Welcome to the *GV-IPCam Quick Start Guide*. In this quick guide, you will find information on the installation and basic configurations of the **GV-IPCam H.264 / H.265 series**.

Camera	Model No.	Lens	Description
Box Camera	GV-BX1500-1F GV-BX2500-1F	Fixed	1.3 MP Low Lux / 1.3 MP / 1.3 MP Super Low Lux / 2 MP WDR Pro / 2 MP Super Low Lux
	GV-BX1500-2F GV-BX2500-2F		1.3 MP Low Lux / 1.3 MP / 1.3 MP Super Low Lux / 2 MP Super Low Lux
	GV-BX2400-1F GV-BX3400-1F	Varifocal	2 MP / 3 MP, WDR Pro,
	GV-BX2400-2F GV-BX3400-2F		2 MP / 3 MP, WDR Pro,

Camera	Model No.	Lens	Description
Box Camera	GV-BX1500-3V GV-BX2500-3V	Varifocal	1.3 MP Low Lux / 1.3 MP / 1.3 MP Super Low Lux / 2 MP Super Low Lux
	GV-BX2600		2 MP, Super Low Lux, WDR Pro
	GV-BX3400-5V		3 MP, WDR Pro
	GV-BX5300-6V		5 MP
	GV-BX1500-8F GV-BX2500-8F GV-BX3400-8F GV-BX5300-8F	Fixed	1.3 MP Super Low Lux / 2 MP Super Low Lux / 3 MP WDR Pro / 5 MP
Box Camera (Coming)	GV-BX1500-3V GV-BX2500-3V GV-BX3400-3V	Varifocal	1.3 MP Low Lux / 2 MP Super Low Lux / 3 MP WDR Pro, P-Iris
	GV-BX5300-6V		5 MP, P-Iris
Box Camera	GV-BX12201	Varifocal	12 MP

Camera	Model No.	Lens	Description
Target Box Camera	GV-EBX1100-0F	Fixed	1.3 MP, Low Lux
	GV-EBX1100-2F		1.3 MP, Low Lux
	GV-EBX2100-0F		2 MP, Low Lux
	GV-EBX2100-2F		2 MP, Low Lux
Ultra Box Camera	GV-UBX1301-0F GV-UBX1301-1F GV-UBX1301-2F	Fixed	1.3 MP
	GV-UBX2301-0F GV-UBX2301-1F GV-UBX2301-2F		2 MP
	GV-UBX3301-0F GV-UBX3301-1F GV-UBX3301-2F		3 MP



Camera	Model No.	Lens	Description
IR Arctic Box Camera	GV-BX1500-E	Varifocal	1.3 MP, Super Low Lux,
	GV-BX2400-E GV-BX3400-E		2 MP / 3 MP, WDR Pro
	GV-BX5300-E		5 MP
	GV-BX2510-E		2 MP Super Low Lux, P-Iris
	GV-BX5310-E		5 MP, P-Iris

Camera	Model No.	Lens	Description
Mini Fixed Rugged Dome	GV-MDR220 GV-MDR320 GV-MDR520	Fixed	2 MP / 3 MP / 5 MP
	GV-MDR1500-1F GV-MDR3400-1F GV-MDR5300-1F	Fixed	1.3 MP Super Low Lux / 3 MP WDR Pro
	GV-MDR1500-2F GV-MDR3400-2F GV-MDR5300-2F		1.3 MP Super Low Lux / 3 MP WDR Pro / 5 MP
Mini Fixed Dome	GV-MFD1501-0F GV-MFD2401-0F GV-MFD2501-0F GV-MFD3401-0F GV-MFD5301-0F	Fixed	1.3 MP Super Low Lux / 2 MP WDR Pro / 2 MP Super Low Lux / 3 MP WDR Pro / 5 MP
	GV-MFD1501-1F GV-MFD2501-1F		1.3 MP Super Low Lux / 2 MP WDR Pro / 2 MP Super Low Lux / 3 MP WDR Pro / 5 MP

Camera	Model No.	Lens	Description
Mini Fixed Dome	GV-MFD1501-2F GV-MFD2401-2F GV-MFD2501-2F GV-MFD3401-2F GV-MFD5301-2F	Fixed	1.3 MP Super Low Lux / 2 MP WDR Pro / 2 MP Super Low Lux / 3 MP WDR Pro / 5 MP
	GV-MFD1501-3F GV-MFD2401-3F GV-MFD2501-3F GV-MFD3401-3F GV-MFD5301-3F		1.3 MP Super Low Lux / 2 MP WDR Pro / 2 MP Super Low Lux / 3 MP WDR Pro / 5 MP
	GV-MFD1501-4F GV-MFD2401-4F		1.3 MP Super Low Lux / 2 MP WDR Pro
	GV-MFD1501-5F GV-MFD2401-5F GV-MFD2501-5F GV-MFD3401-5F GV-MFD5301-5F		1.3 MP Super Low Lux / 2 MP WDR Pro / 5 MP Super Low Lux
	GV-MFD2501-6F GV-MFD3401-6F		2 MP Super Low Lux / 3 MP WDR Pro
	Target Mini Fixed Dome		GV-EFD1100-0F GV-EFD2100-0F
GV-EFD1100-2F GV-EFD2100-2F		1.3 MP / 2 MP, Low Lux	

Camera	Model No.	Lens	Description	
Target Mini Fixed Rugged Dome	GV-EDR1100-0F GV-EDR2100-0F	Fixed	1.3 MP Low Lux / 2 MP Low Lux	
	GV-EDR1100-2F GV-EDR2100-2F		1.3 MP Low Lux / 2 MP Low Lux	
Bullet Camera	GV-BL1500 GV-BL2400 GV-BL2500 GV-BL3400	Varifocal	1.3 MP Super Low Lux / 2 MP WDR Pro / 2 MP Super Low Lux / 3 MP WDR Pro	
	GV-BL3700		3 MP, H.265, Super Low Lux, WDR Pro	
	GV-BL5700		5 MP, H.265, Low Lux, WDR	
	GV-BL1210 GV-BL2410 GV-BL3410	Motorized Varifocal	1.3 MP Low Lux / 2 MP WDR Pro / 3 MP WDR Pro, 3X Optical Zoom	
	GV-BL5310	Motorized Varifocal	5 MP, 2X Optical Zoom	
	GV-BL1501 GV-BL2501 GV-BL3401	Varifocal	1.3 MP Super Low Lux / 2 MP Super Low Lux / 3 MP WDR Pro, P-Iris	
	GV-BL1511 GV-BL2511 GV-BL3411		Motorized varifocal	1.3 MP Super Low Lux / 2 MP Super Low Lux / 3 MP WDR Pro, P-Iris, 3X Optical Zoom
	GV-BL5311			5 MP, 2X Optical Zoom, P-Iris

IR Arctic Bullet Camera	GV-BL2511-E	Varifocal Motorized	2 MP Super Low Lux, 3X Optical Zoom, P-Iris
	GV-BL5311-E		5 MP, 2X Optical Zoom, P-Iris

Camera	Model No.	Lens	Description
Target Bullet Camera	GV-EBL1100-1F GV-EBL2100-1F	Fixed	1.3 MP / 2 MP, Low Lux
	GV-EBL1100-2F GV-EBL2100-2F		1.3 MP Low Lux
	GV-EBL2101	Varifocal	2 MP, Super Low Lux, P-Iris
Ultra Bullet Camera	GV-UBL1211 GV-UBL1511 GV-UBL2411 GV-UBL2511 GV-UBL3411	Motorized Varifocal	1.3 MP Low Lux / 1.3 MP Super Low Lux / 2 MP WDR Pro / 2 MP Super Low Lux / 3 MP WDR Pro, Auto Iris, 3X Optical Zoom
	GV-UBL1301-0F GV-UBL1301-1F GV-UBL1301-2F GV-UBL1301-3F	Fixed	1.3 MP
GV-UBL2401-0F GV-UBL2401-1F GV-UBL2401-2F GV-UBL2401-3F	2 MP, WDR Pro		

Camera	Model No.	Lens	Description
Ultra Bullet Camera	GV-UBL3401-0F	Fixed	3 MP, WDR Pro
	GV-UBL3401-1F		3 MP, WDR Pro
	GV-UBL3401-2F		
	GV-UBL3401-3F		
Fixed IP Dome	GV-FD1200	Varifocal	1.3 MP Low Lux / 2 MP WDR Pro
	GV-FD2400		
	GV-FD1500		1.3 MP Super Low Lux / 2 MP Super Low Lux / 3 MP WDR Pro
	GV-FD2500		
	GV-FD3400		
	GV-FD1210	Motorized Varifocal	1.3 MP Low Lux / 2 MP WDR Pro, 3x Optical Zoom
GV-FD2410			

Camera	Model No.	Lens	Description
Fixed IP Dome	GV-FD1510 GV-FD2510 GV-FD3410	Motorized Varifocal	1.3 MP Super Low Lux / 2 MP Super Low Lux / 3 MP WDR Pro, 3x Optical Zoom
Fixed IP Dome	GV-FD1500 GV-FD2500 GV-FD3400	Varifocal	1.3 MP Super Low Lux / 2 MP Super Low Lux / 3 MP WDR Pro, P-Iris
	GV-FD1510 GV-FD2510 GV-FD3410	Motorized Varifocal	1.3 MP Super Low Lux / 2 MP Super Low Lux / 3 MP WDR Pro, 3x Optical Zoom, P-Iris
Target Fixed IP Dome	GV-EFD2101	Varifocal	2MP Super Low Lux, WDR, P-iris
	GV-EFD3101		3MP Super Low Lux, WDR Pro, P-Iris
	GV-EFD5101		5MP Low Lux, WDR, P-Iris
Advanced Cube Camera	GV-CA120 GV-CA220	Fixed	1.3 MP / 2 MP
	GV-CAW120 GV-CAW220		1.3 MP / 2 MP, Wireless
Cube Camera	GV-CB120 GV-CB220	Fixed	1.3 MP / 2 MP
PT Camera	GV-PT130D GV-PT220D GV-PT320D	Fixed	1.3 MP / 2 MP / 3 MP



Camera	Model No.	Lens	Description
Vandal Proof IP Dome	GV-VD120D (IK10+, Transparent Cover) GV-VD121D (IK10+, Smoked Cover) GV-VD122D (IK7, Transparent Cover) GV-VD123D (IK7, Smoked Cover)	Varifocal	1.3 MP, Low Lux
	GV-VD220D (IK10+, Transparent Cover) GV-VD221D (IK10+, Smoked Cover) GV-VD222D (IK7, Transparent Cover) GV-VD223D (IK7, Smoked Cover)		2 MP
	GV-VD320D (IK10+, Transparent Cover) GV-VD321D (IK10+, Smoked Cover) GV-VD322D (IK7, Transparent Cover) GV-VD323D (IK7, Smoked Cover)		3 MP
	GV-VD1500 (IK10+, Transparent Cover) GV-VD2400 (IK10+, Transparent Cover) GV-VD2500 (IK10+, Transparent Cover) GV-VD3400 (IK10+, Transparent Cover)		1.3 MP Super Low Lux / 2 MP WDR Pro / 2 MP Super Low Lux / 3 MP WDR Pro

Camera	Model No.	Lens	Description
Vandal Proof IP Dome	GV-VD3700	Varifocal lens	3 MP H.265, WDR Pro, Super Low Lux
	GV-VD5700		5 MP H.265, WDR, Low Lux
	GV-VD1530 GV-VD2430 GV-VD2530 GV-VD3430	High Power IR LEDs, Varifocal	1.3 MP Super Low Lux / 2 MP WDR Pro / 2 MP Super Low Lux / 3 MP WDR Pro
	GV-VD1540 GV-VD2440 GV-VD2540 GV-VD3440	High Power IR LEDs, Motorized Varifocal	1.3 MP Super Low Lux / 2 MP WDR Pro / 2 MP Super Low Lux / 3 MP WDR Pro, 3X Optical Zoom
	GV-VD5340		5 MP, 3X Optical Zoom
	GV-VD2540-E	High Power IR LEDs, Motorized Varifocal Lens, Extreme Temperature Tolerance	2 MP Super Low Lux, 3X Optical Zoom
	GV-VD5340-E		5 MP, 3X Optical Zoom
Target Vandal Proof IP Dome	GV-EVD2100	Varifocal	2MP Super Low Lux, WDR, P-Iris
	GV-EVD3100		3MP Super Low Lux, WDR Pro, P-Iris
	GV-EVD5100		5MP Low Lux, WDR, P-Iris
Pinhole Camera	GV-UNP2500	Fixed	2 MP Super Low Lux

For detailed manuals, see *GV-IPCAM Firmware Manual* and *GV-IPCAM Hardware Manual* on the Software DVD.

## Options

Optional devices can expand your camera's capabilities and versatility. Contact your dealer for more information.

Accessory	Description
Power Adapter	The power adapter is available for all GV-IP Camera (except for IR Arctic Cameras, Mini Fixed Rugged Dome and GV-BL2510-E / 5310-E). Contact your sales representative for the countries and areas supported.
GV-PA191 PoE Adapter	The GV-PA191 PoE adapter is designed to provide power and network connection to the cameras over a single Ethernet cable.
GV-PA481 PoE Adapter	The GV-PA481 PoE adapter is designed to provide power and network connection to GV-BX1200-E / 2400-E / 3400-E / 5300-E over a single Ethernet cable.
GV-PA482 PoE Adapter	The GV-PA482 PoE adapter is designed to provide power and network connection to GV-BX2510-E / 5310-E over a single Ethernet cable.
GV-POE Switch	The GV-POE Switch is designed to provide power along with network connection for IP devices. The GV-POE Switch is available in various models with different numbers and types of ports.
GV-Mount Accessories	The GV-Mount Accessories provide a comprehensive lineup of accessories for installation on ceiling, wall corner and pole. For details, see <i>GV-Mount Accessories Installation Guide</i> on the Software DVD.

Accessory	Description
GV-WiFi Adapter	The GV-WiFi Adapter is a plug-and-play device designed to connect GV-BX1200 Series / 1500 series / 2400 series / 2500 series / 3400 series / 5300 series and GV-MFD1501 series / 2401 series / 2501 series / 3401 series / 5301 series to wireless network. This product complies with IEEE 802.11 b/g/n (Draft 3.0) standards for wireless networking.
GV-Relay V2	The GV-Relay V2 is designed to expand the voltage load of GV IP devices. It provides 4 relay outputs, and each can be set as normally open (NO) or normally closed (NC) independently as per your requirement. GV-Relay V2 does not support GV-EVD2100 / 3100 / 5100.
Smoked Cover	The smoked cover is an IK7, tinted camera cover designed for GV-Fixed IP Dome to conceal the direction of the camera lens.
Plastic PG21 Conduit Connector	The plastic PG21 conduit connector is used for running the wires of Target Mini Fixed Rugged Dome through a 1/2" conduit pipe.
Metal PG21 Conduit Connector	The metal PG21 conduit connector is used for running the wires of GV-VD1530 / 2430 / 2530 / 3430, GV-VD1540 / 2440 / 2540 / 3440 / 5340 and GV-VD2540-E / 5340-E and GV-EVD2100 / 3100 / 5100 through a 3/4" conduit pipe.

## Note for Connecting to GV-System / GV-VMS

The GV-IPCAM H.264 is designed to work with GV-System / GV-VMS, a hybrid or digital video management system. Note the following when GV-IPCAM H.264 is connected to GV-System / GV-VMS:

1. By default, the images are recorded to the memory card inserted to the **GV-IP Camera H.264** (except GV-IR Arctic Camera and Target Series, which are not equipped with a memory card slot).
2. Once the camera is connected to GV-System / GV-VMS, the resolution set on GV-System / GV-VMS will override the resolution set on the camera's Web interface. You can only change the resolution settings through the Web interface when the connection to GV-System / GV-VMS is interrupted.

## Note for Recording

1. By default, the images are recorded to the memory card inserted to the **GV-IP Camera** (except GV-IR Arctic Camera and Target Series, which are not equipped with a memory card slot). Make sure the **Write recording data into local storage** option is enabled. If this option is disabled, the camera will stop recording to the memory card while the live view is accessed through Web browsers or other applications. For details, see *Video Settings, Administrator Chapter, GV-IPCAM Firmware Manual* on the Software DVD).
2. Mind the following when using a memory card for recording:
  - Recorded data on the memory card can be damaged or lost if the data are accessed while the camera is under physical shock, power interruption, memory card detachment or when the memory card reaches the end of its lifespan. No guarantee is provided for such causes.
  - The stored data can be lost if the memory card is not accessed for a long period of time. Back up your data periodically if you seldom access the memory card.
  - Memory cards are expendable and their durability varies according to the conditions of the installed site and how they are used. Back up your data regularly and replace the memory card annually.
  - Replace the memory card when its read/write speed is lower than 6 MB/s or when the memory card is frequently undetected by the camera.
3. It is recommended to use memory cards of the following setting and specifications:
  - Apply a battery backup (UPS) to avoid power outage.
  - Use Micro SD card of MLC NAND flash, Class 10 for better performance.

## Note for Adjusting Focus and Zoom

When adjusting the Focus and Zoom Screws (on Box Camera, IR Arctic Box Camera, Mini Fixed Dome, Bullet Camera, Vandal Proof IP Dome and Fixed IP Camera), please do not over tighten the Focus and Zoom screws. The screws only need to be as tight as your finger can do it; don't bother using any tools to get them tighter. Doing so can damage the structure of lens.

For example,

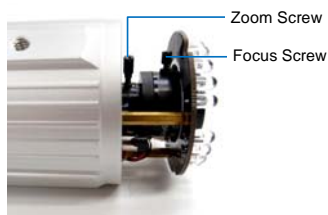

**Bullet Camera**



**Fixed IP Camera**

The maximum torque value for all the zoom and focus screws is 0.049 N.m

## Note for Installing Camera Outdoor

When installing the **IR Arctic Box Camera**, **Bullet Camera**, **Ultra Bullet Camera**, **Target Bullet Camera**, **Vandal Proof IP Dome**, **Mini Fixed Rugged Dome** or **Target Mini Fixed Rugged Dome** outdoor, be sure that:

1. The camera is set up above the junction box to prevent water from entering the camera along the cables.

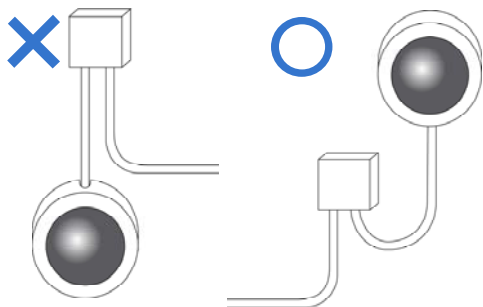

2. Any PoE, power, audio and I/O cables are waterproofed using waterproof silicon rubber or the like.

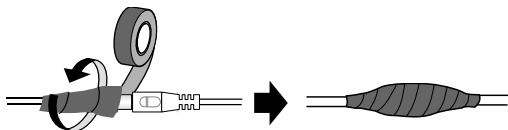



3. After opening the camera cover, ensure the screws are tightened and the cover is in place.



4. Make sure the housing cover is properly secured to prevent water from entering and damaging the inner housing.

## Note for Closing the Bullet Camera Cover

To ensure that the camera performs its full capacity against water and dust, tightly close and lock the camera cover as indicated below.

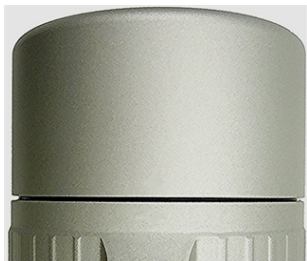

## Note for Bullet Waterproof Failures

To avoid waterproofing failures, do not open the screw on the camera body.

- The screw on Ultra Bullet Camera



- The screw on Target Bullet Camera



- The screw on GV-EBL2101



- The screw on GV-BL3700 / 5700



## Note for USB Storage and WiFi Adapter

Mind the following limitations and requirements for using USB storage and GV-WiFi Adapter:

1. The USB hard drive must be of 2.5" or 3.5", version 2.0 or above.
2. The USB hard drive's storage capacity must not exceed 2TB.
3. USB flash drives and USB hubs are not supported.
4. External power supply is required for the USB hard drive.
5. To connect a GV-WiFi Adapter, make sure it is connected before the camera is powered on.

## Note for Silica Gel Bags

1. The silica gel bag loses its effectiveness when the dry camera is opened. To prevent the lens from fogging up, replace the silica gel bag every time you open the camera, and conceal the gel bag in camera within 2 minutes of exposing to open air.
2. When the camera is shipped, a silica gel bag will be included inside the camera. For the first-time user, replace the silica gel bag prior to the installation to avoid foggy live view.

# 1. Box Camera

## 1.1 Packing List

- Box Camera
- Terminal Block
- Fixed Focal or Varifocal Megapixel Lens
- Six Lens Rings
- Video Out Wire
- Camera Holder
- Power Adapter
- GV-IPCAM Software DVD
- GV-NVR Software DVD
- Warranty Card

**Note:** The power adapter can be excluded upon request.

## 1.2 Overview

**GV-BX1200 Series / 1500 Series / 2400 Series / 2500 Series / 2600 / 3400 Series / 5300 Series / 12201**

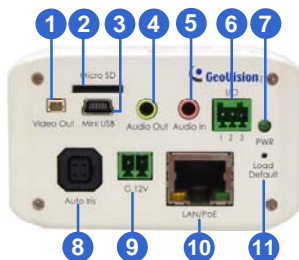

*GV-BX1200 Series / 1500 Series /  
2400 Series / 2500 Series / 2600 /  
3400 Series / 5300 Series*

*GV-BX12201*

**Note:**

1. The Auto Iris Connector (No. 8) is only functional for varifocal models of GV-BX1200 / 1500 / 2400 / 2500 / 2600 / 3400.
2. The Iris Screw (No. 12) is only available for GV-BX5300-6V.
3. The Zoom Screw (No. 13) is only available for varifocal models of GV-BX1200 / 1500 / 2400 / 2500 / 2600 / 3400 / 5300 / 12201
4. Built-in microphone is not available for GV-BX2600.
5. The Memory Card Slot (No. 2) is currently not supported for GV-BX12201.
6. Mini USB Slot (No. 3) connected to USB hard drive is currently not supported for GV-BX12201.

No.	Name	Description
1	Video Out	Connects to a portable monitor for setting the focus and angle of Box Camera during initial installation.
2	Memory Card Slot	Receives a micro SD card (SD/SDHC, version 2.0 only, Class 10) to store recording data.
3	Mini USB Slot	Connects to a GV-WiFi Adapter or a USB hard drive.
4	Audio Out	Connects a speaker for audio output.
5	Audio In	Connects a microphone for audio input.
6	I/O Terminal Block	Connects I/O devices. For details, see <i>I/O Terminal Block, Box Camera Chapter, GV-IPCAM Hardware Manual on the Software DVD.</i>
7	Power LED	Indicates the power is supplied. For detail, see the table below.
8	Auto Iris Connector	Plug the iris control cable to the connector.

No.	Name	Description
9	DC 12V Port	Connects to power.
10	LAN / PoE	Connects to a 10/100 Ethernet or PoE.
11	Default	Resets the camera to default settings. See 27. <i>Restoring to Default Settings</i> later in the <i>Quick Start Guide</i> .
12	Iris Screw	Adjusts the iris of the camera.
13	Zoom Screw	Adjusts the zoom of the camera.
14	Microphone	Records the sounds.
15	Focus Screw	Adjusts the focus of the camera.
16	Status LED	Turns on when the unit is ready for use. For detail, see the table below.

LED	Description
Power LED turns green	The system powers on and succeeds to boot up.
Status LED turns green	The system is ready for use.



## 1.3 Accessory Installation

### 1.3.1 C-Mount Lenses

When you use a C-mount lens, it requires a certain distance from the camera's imaging chip to focus the lens. Mount the supplied C-mount lens adapter / lens ring to the camera, and then attach the lens onto the camera body.

#### Box Camera

Three types of lens rings are provided for Box Camera:

- 0.188 mm (transparent color) x 2
- 0.254 mm (black color with a matt surface) x 2

**Note:** These lens rings are specially designed for varifocal models of Box Camera. Besides the supplied lens rings, each varifocal model has already been installed with the necessary lens ring.



### 1.3.2 Infrared Illuminators (Optional)

1. Connect the infrared illuminator to the terminal block on the camera. See *I/O Terminal Block, Box Camera* Chapter, *GV-IPCAM Hardware Manual* on the Software DVD.
2. Access the Web interface of the camera.



3. Select **Video and Motion**, select **Video Settings**, select **Streaming 1** and set the **IR Check Function** setting to **Triggered by Input**.

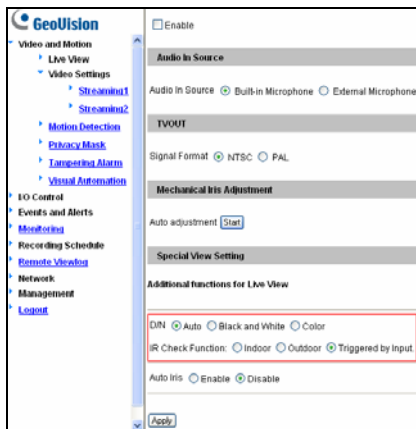

4. Click **Apply**.

For details on the **Trigger by Input** function, see the *Video Settings* section, *Administrator Mode* Chapter in the *GV-IPCAM Firmware Manual* in the Software DVD.

## 1.4 Connecting the Camera

The Box Camera is designed for indoor use. Please make sure the installing site is shielded from rain and moisture.

**GV-BX1200 Series / 1500 Series / 2400 Series / 2500 Series / 2600 / 3400 Series / 5300 Series/ 12201**

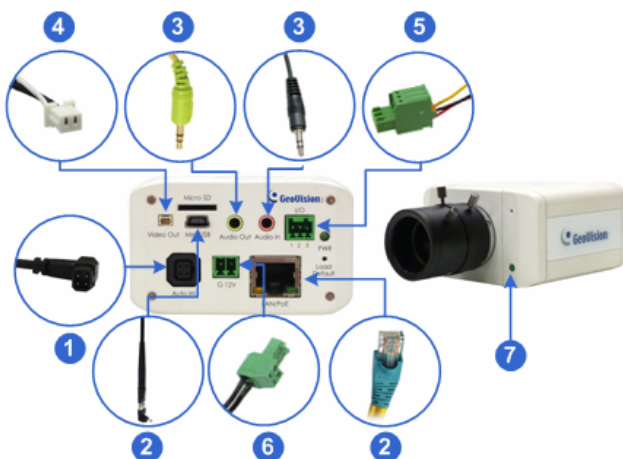

1. If you are using an auto iris model, plug the iris control cable to the Auto Iris Connector on the camera.
2. Connect to network using one of the following methods:
  - **Wired Connection:** Use a standard network cable to connect the camera to your network and optionally connect a USB hard drive to the mini USB port.

- Wireless Connection: Optionally purchase and connect the GV-WiFi Adapter.
3. Optionally connect a speaker and an external microphone.
  4. Optionally connect a monitor using a Video Out wire. Enable this function by selecting your signal format at the **TV Out** field on the Web interface. See *TV Out setting*, in the *Video Settings* section, *Administrator Mode* Chapter, *GV-IPCAM Firmware Manual* on the Software DVD.
  5. Optionally connect to input / output devices or an infrared illuminator. For details, see *Infrared Illuminator* and *I/O Terminal Block, Box Camera* Chapter, *GV-IPCAM Firmware Manual* on the Software DVD.
  6. Connect power using one of the following methods:
    - Plug the power adapter to the power port.
    - Use the Power over Ethernet (PoE) function and the power will be provided over the network cable.
  7. The status LED of the camera will be on.
  8. You are ready to access the live view and adjust the image clarity. See *24. Accessing the Camera* in the *Quick Start Guide*.

**Note:** For details on limitations and requirements of the mini USB port, refer to *Note for USB Storage and WiFi Adapter* at the beginning of this quick guide.

## 2. Ultra Box Camera

### 2.1 Packing List



- Ultra Box Camera
- Supporting rack
- Screw x 3
- Screw anchor x 3
- Power Adapter
- GV-IPCAM Software DVD
- GV-NVR Software DVD
- Warranty Card

**Note:** The power adapter can be excluded upon request.

## 2.2 Overview



No.	Name	Description
1	Audio Out	Connects a speaker for audio output.
2	Default	Resets the camera to default settings. See 27 <i>Restoring to Default Settings</i> in the <i>Quick Start Guide</i> .
3	LAN / PoE	Connects to a 10/100 Ethernet or PoE.
4	Microphone	Records sounds.
5	Memory Card Slot	Receives a micro SD card (SD/SDHC, version 2.0 only, Class 10) to store recording data.
6	DC 5V Terminal Block	Connects to power.

LED Indicator	Description
 Status LED	The status LED turns on (green) when the system is ready for use.
 Power LED	The power LED turns on (green) when power is supplied to the camera.

## 2.3 Installation

You can stand the Ultra Box Camera on a plain surface or install it to wall and ceiling. Follow the steps below to install, connect and adjust your Ultra Box Camera.

1. To install the device on the wall/ceiling, put the supporting rack on the desired location and make marks for screw anchors.



2. Drill the marks and insert the screw anchors.
3. Secure the supporting rack onto the wall/ceiling using the supplied screws.
4. Secure the camera onto the supporting rack and fasten the indicated screw.



5. Connect the network and power cables to the camera. See 2.4 *Connecting the Camera* in the *Quick Start Guide*.
6. Access the live view. See 24.2 *Accessing the Live View* in the *Quick Start Guide*.
7. Adjust the angle of the camera based on live view and fasten the indicated screw.





## 2.4 Connecting the Camera



1. Connect power using one of the following methods:
  - Plug the power adapter to the 5V terminal block.
  - Use the Power over Ethernet (PoE) function and the power will be provided over the network cable.

The power and status LEDs shall turn on (green).

2. Use a standard network cable to connect the camera to your network.
3. Optionally connect a speaker.
4. Insert a micro SD card (SD/SDHC, version 2.0 only, Class 10).
5. You are ready to access the live view, adjust the image clarity and configure the basics. See *24. Accessing the Camera* in the *Quick Start Guide*.

## 3. Target Box Camera

### 3.1 Packing List



- Target Box Camera
- Supporting Rack
- Screw x 3
- Screw Anchor x 3
- GV-IPCAM Software DVD
- GV-NVR Software DVD
- Warranty Card

**Note:** Power adapter can be purchased upon request.

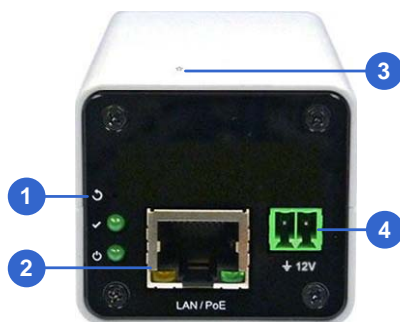
## 3.2 Overview



No.	Name	Description
1	Default	Resets the camera to default settings. See 27. <i>Restoring to Default Settings</i> in the <i>Quick Start Guide</i> .
2	LAN / PoE	Connects to a 10/100 Ethernet or PoE.
3	Microphone	Records sounds.
4	DC 12V Terminal Block	Connects to power.

LED Indicator	Description
 Status LED	The status LED turns on (green) when the system is ready for use.
 Power LED	The power LED turns on (green) when power is supplied to the camera.

### 3.3 Installation

You can stand the Target Box Camera on a plain surface or install it to wall and ceiling. Follow the steps below to install, connect and adjust your Target Box Camera.

1. To install the device on the wall/ceiling, put the supporting rack on the desired location and make marks for screw anchors.



2. Drill the marks and insert the screw anchors.
3. Secure the supporting rack onto the wall/ceiling using the supplied screws.
4. Secure the camera onto the supporting rack and fasten the indicated screw.



5. Connect the network and power cables to the camera. See 3.4 *Connecting the Camera* in the *Quick Start Guide*.
6. Access the live view. See 24.2 *Accessing the Live View* in the *Quick Start Guide*.
7. Adjust the angle of the camera based on live view and fasten the indicated screw.



## 3.4 Connecting the Camera



1. Connect power using one of the following methods:
  - Plug the power adapter to the 12V terminal block. The power adapter is an optional device. For detail, see *Options* in the *GV-IPCAM Hardware Manual* for Target Box Camera on the Software DVD.
  - Use the Power over Ethernet (PoE) function and the power will be provided over the network cable. The power and status LEDs shall turn on (green).
2. Use a standard network cable to connect the camera to your network.
3. You are ready to access the live view, adjust the image clarity and configure the basics. See 24. *Accessing the Camera* in the *Quick Start Guide*.

## 4. IR Arctic Box Camera

### 4.1 Packing List

For GV-BX1500-E / 2400-E / 3400-E / 5300-E

- IR Arctic Box Camera
- Screw Anchor x 4
- Screw x 4
- Washer x 4
- 4 mm Torx Wrench
- 5 mm Torx Wrench
- Silica Gel Bag x 2
- Adhesive Tape x 2
- GV-IPCAM Software DVD
- GV-NVR Software DVD
- Warranty Card

**Note:** Optionally purchase a GV-PA481 PoE Adapter for GV-BX1500-E / 2400-E / 3400-E / 5300-E.

#### For GV-BX2510-E / 5310-E

- IR Arctic Box Camera
- Screw Anchor x 4
- Screw x 4
- Washer x 4
- 5 mm Torx Wrench
- Silica Gel Bag
- Adhesive Tape
- Power Adapter (DC 48V, 2.5A, 120 W max.)
- GV-IPCAM Software DVD
- GV-NVR Software DVD
- Warranty Card

**Note:** Optionally purchase a GV-PA482 PoE Adapter for GV-BX2510-E / 5310-E.



## 4.2 Overview

For GV-BX1500-E / 2400-E / 3400-E / 5300-E

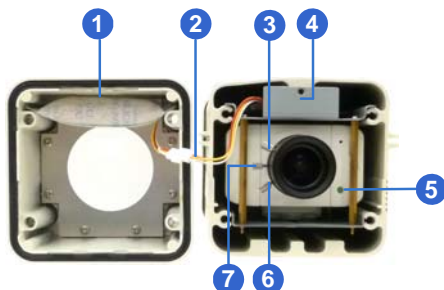

**Note:** The Iris Screw (no. 7) is only available in GV-BX5300-E.

No.	Name	Description
1	Silica gel bag	Desiccant that keeps the camera housing dry.
2	IR power plug	Supplies power to the built-in IR LEDs.
3	Focus Screw	Adjusts the focus of the camera.
4	Module screw	Holds the module in place.
5	Status LED	Turns on when the camera is ready for use.
6	Zoom Screw	Adjusts the zoom of the camera.
7	Iris Screw	Adjusts the iris of the camera.

For GV-BX2510-E / 5310-E

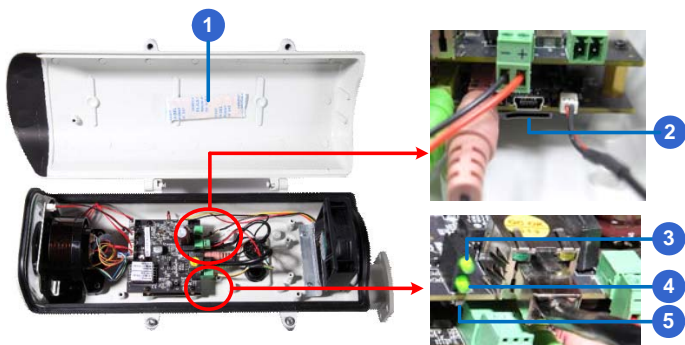

No.	Name	Description
1.	Silica gel bag	Desiccant that keeps the camera housing dry.
2.	Memory Card Slot	Inserts a micro SD card (SD/SDHC, version 2.0, Class 10) to store recording data.
3.	Power LED	Turns on when the camera is supplied with power.
4.	Status LED	Turns on when the camera is ready for use.
5.	Default	Resets the camera to default settings. See 27. <i>Restoring to Default Settings</i> later in the <i>Quick Start Guide</i> .

## 4.3 Installation

The IR Arctic Box Camera is designed for outdoor use. Follow the steps below to install your camera.

1. Mark the installation site and drill four holes for screw anchors.
2. Insert the supplied screw anchors.
3. Secure the camera to the wall using the supplied washers and screws.

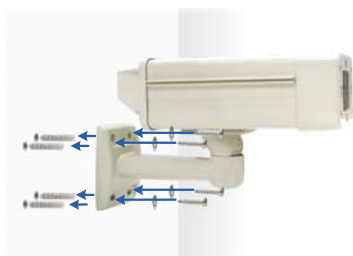

4. Connect the camera with wires and cables. See *4.4 Connecting the Camera* in the *Quick Start Guide*.
5. Access the live view. See *24.2 Accessing the Live View* in the *Quick Start Guide*.

6. Based on the live view, adjust the angle of the camera. Loosen the indicated screw with the supplied big torx wrench and adjust the joint.



### Tilt Adjustment



### Pan Adjustment



7. For GV-BX1500-E / 2400-E / 3400-E / 5300-E, adjust for image clarity based on the live view.
  - A. Unscrew the cover with the supplied 4 mm torx wrench.



- B. Hold and unplug the connector.

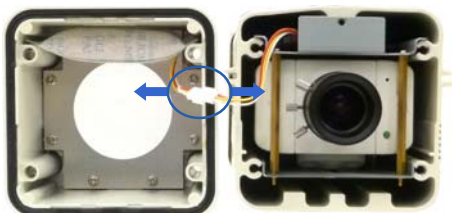

**IMPORTANT:** Unscrew and remove the cover carefully. Pulling the cover off may cause damages to the inner wiring of the camera.

- C. Adjust the focus, zoom and iris screws. For a more precise focus, use GV-IP Device Utility. For details, see 24.3 *Adjusting Image Clarity* in the *Quick Start Guide*.

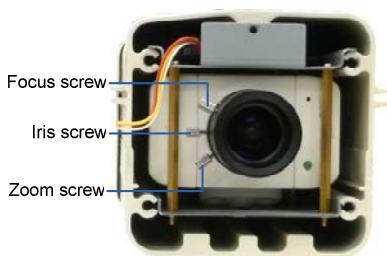

**Note:** Only GV-BX5300-E contains an iris screw.

- D. Replace the silica gel bag. Paste the sticker to the front side of the silica gel bag. Press the sticker several times to make sure it adheres properly and paste the silica gel bag to the indicated place.



- E. Follow steps 7B and 7A to plug the connectors back and close the camera cover.

8. For GV-BX2510-E / 5310-E, optionally insert a memory card.
- A. Open the camera cover using the supplied torx wrench.



- B. Insert a memory card to the card slot.

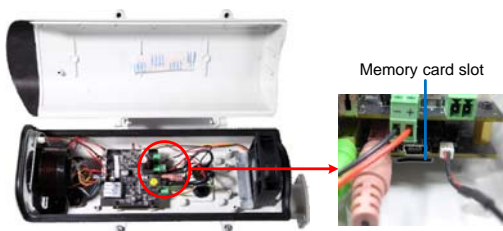

- C. Replace the silica gel bag. Paste the sticker to the silica gel bag. Press the silica gel bag several times onto the camera cover to make sure it adheres properly.



- D. Follow step 8A to close the camera cover.

## 4.4 Connecting the Camera

For GV-BX1500-E / 2400-E / 3400-E / 5300-E

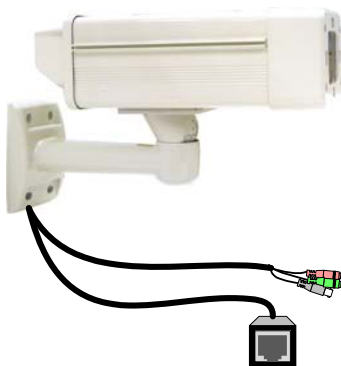

No.	Wire	Definition
1	RJ-45	PoE
2	Black BNC	TV out
3	Green RCA	Audio Out
4	Pink RCA	Audio In

Follow the steps below to connect the camera:

1. Optionally connect a speaker (green) and an external microphone (pink).
2. Optionally connect a monitor using a Video Out wire. Enable this function by selecting your signal format at the **TV Out** field on the Web interface. See *Video Settings* section, *Administrator Mode* Chapter, *GV-IPCAM Firmware Manual* on the Software DVD.



3. Connect the camera to a GV-PA481 PoE adapter as illustrated to supply power and network access.

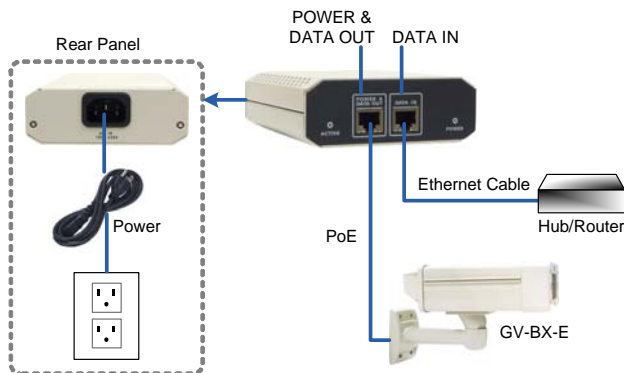

4. The status LED of the camera will be on.
5. You are ready to access the live view.

**Note:** For using the IR Arctic Box Camera, ensure that you:

1. **enable the IR LED** function on the Web interface after loading the default settings.
2. **disable the status LED** to reduce reflection when a green light spot appears on the live view.

For details, see *Notice for Using the IR Arctic Box Camera* section, *IR Arctic Box Camera Chapter, GV-IPCAM Firmware Manual* on the Software DVD.

For GV-BX2510-E / 5310-E



No.	Wire	Definition
1.	Green RCA	Audio Out
2.	Pink RCA	Audio In
3.	Brown wire	Digital Output
4.	Yellow wire	Digital Input
5.	White wire	GND
6.	Terminal Block	DC 48V
7.	BNC	TV Out
8.	RJ-45	Ethernet/PoE++

1. Optionally connect the audio out (green), audio in (pink), digital output (brown), digital input (yellow), and GND.
2. Optionally connect a monitor using a Video Out wire. Enable this function by selecting your signal format at the **TV Out** field on the Web interface. See *Video Settings* section, *Administrator Mode* Chapter, *GV-IPCAM Firmware Manual* on the Software DVD.

3. Supply the camera with power and network access using one of the following methods:

- Use a GV-PA482 Power over Ethernet adapter to connect the camera to power and network as illustrated below. GV-PA482 PoE adapter is an optional accessory. For detail, see *Options* in the *Quick Start Guide*.

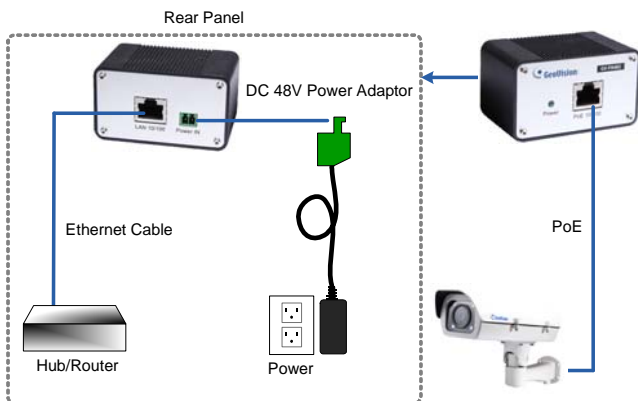

- Use the supplied power adapter. Connect the black wire of the power adaptor to the plus (+) port and the white wire to the negative (-) port. Connect the camera to network with a network cable.



4. You are ready to access the live view.

## 5. Mini Fixed Dome & Mini Fixed Rugged Dome

### 5.1 Packing List

#### GV-MFD

- Mini Fixed Dome
- Torx Wrench
- Self Tapping Screw x 2
- Screw Anchor x 2
- Cable stopper
- 2-pin terminal block
- Short-Body RJ-45 Plug (for GV-MFD1501 series / 2401 series / 2501 series / 3401 series / 5301 series)
- USB / Audio Y-cable (for GV-MFD1501 series / 2401 series / 2501 series / 3401 series / 5301 series)
- Power Adapter
- GV-IPCAM Software DVD
- GV-NVR Software DVD
- Warranty Card

**Note:** The power adapter can be excluded upon request.

**GV-MDR**

- Mini Fixed Rugged Dome
- Torx Wrench
- Self Tapping Screw x 2
- Screw Anchor x 2
- Cable stopper
- Cable Connector
- Installation sticker
- Silica gel bag x 2
- Adhesive Tape x 2
- Ferrite core for vehicle installation
- GV-IPCAM Software DVD
- GV-NVR Software DVD
- Warranty Card

**Note:**

1. The power adapter can be excluded upon request.
2. When purchasing **GV-MDR1500 / 3400 / 5300**, choose one of the two LAN connector types (for motor vehicles or for general use). For details, see *LAN Connector, 5.2 Overview* in the *Quick Start Guide*.

## 5.2 Overview

### GV-MFD1501 Series / 2401 Series / 2501 Series / 3401 Series / 5301 Series

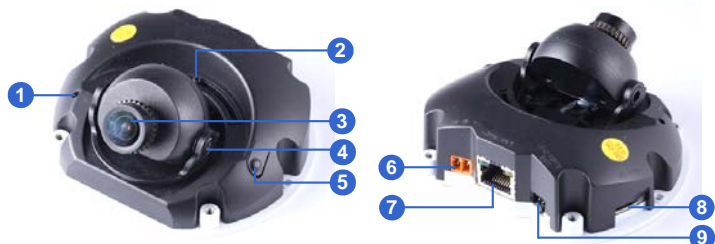

No.	Name	Description
1	Microphone	Receives sound.
2	Pan Screw	Loosens the screw to pan.
3	Lens	Receives image inputs.
4	Tilt Screw	Loosens the screw to adjust tilt angle.
5	Default Button	Resets the camera to default settings. See <i>27. Restoring to Default Settings</i> .
6	DC 5V Power Port	Connects to power.
7	LAN / PoE	Connects to a 10/100 Ethernet or PoE.
8	Memory Card Slot	Inserts a micro SD card (SD/SDHC, version 2.0, Class 10) to store recording data.
9	USB and Audio Out	Connects to an external hard disk drive and a speaker through the supplied Y cable.

**Note:** For details on limitations and requirements of the USB port, refer to *Note for USB Storage and WiFi Adapter* at the beginning of the Quick Guide.

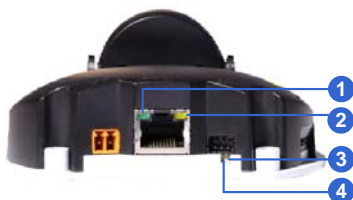

LED Name	Description
1. Link	Turns on (green) when the network is connected.
2. ACT	Turns on (orange) when data are being transmitted.
3. Status	Turns on (red) when the system is ready.
4. Power	Turns on (green) when power is on.

## GV-MDR



No.	Name	Description
1	Silica gel bag	Absorbs the moisture inside the camera.
2	Conceal paper	Prevents water or moisture from entering the camera.
3	Lens	Receives image inputs.
4	Rotation Disc	Rotates the camera lens.
5	Pan Disc	Pans the camera lens.
6	Tilt Screw	Loosens to tilt the camera.
7	Built-In Microphone	Provides one-way audio.
8	Default Button	Resets the camera to default settings. See 27. <i>Restoring to Default Settings</i> later in the <i>Quick Start Guide</i> .



No.	Name	Description
9	Power and status LED	Turns red when the power is on. Flashes orange light twice when the system is ready.
10	LAN LED	Turns on when the network is connected.
11	Memory Card Slot	Receives a micro SD card (SD/SDHC, version 2.0 only, Class 10) to store recording data.

**IMPORTANT:** In case of damage and possible condensation inside the camera housing, be sure not to touch or remove the conceal paper.

## LAN Connector

Two types of LAN connector are available for GV-MDR1500 series / 3400 series / 5300 series. Select an option based on your installation environment.

### 1. Waterproof M12 4-Pin Female Connector

The M12 connector is used for motor vehicles.

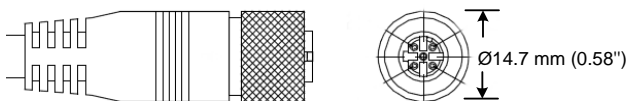

### 2. Small Waterproof Connector

For this connector type, see *GV-MDR, 5.3 Installation* to install the supplied cable connector.

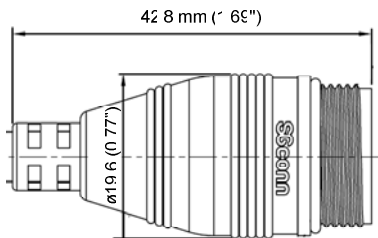

## 5.3 Installation

To install a Mini Fixed Dome, make sure the installing site is shielded from rain and moisture.

### GV-MFD Series

1. Unscrew the housing cover using the supplied torx wrench.
2. Put the camera on the desired location and make 2 marks on the ceiling for screw anchors. If you want to run the cables inside the ceiling, make a round mark with a diameter of 2.5 cm.
3. Drill the marks and insert the screw anchors.
4. Secure the Mini Fixed Dome to the ceiling with the self-tapping screws.
5. Connect the camera to network and power. For details, see 5.4 *Connecting the Camera* in the *Quick Start Guide*.
6. Access the live view. See 24.2 *Accessing the Live View* in the *Quick Start Guide*.
7. Adjust the angles based on the live view.

#### Pan Adjustment



### Tilt Adjustment



8. Insert a memory card (SD/SDHC, version 2.0 only, Class 10) into the memory card slot.



9. Adjust image clarity using the GV-IP Device Utility program. For details, see *24.3 Adjusting Image Clarity* in the *Quick Start Guide*.
10. Secure the housing cover using the supplied torx wrench.
11. Optionally conceal the cable opening with the supplied cable stopper.



## GV-MDR Series

1. Paste the installation sticker on the desired location. The arrow should point toward the direction that the camera faces.
2. Drill one hole on each of the two curves for screw anchors. Drill the circle (30 mm in diameter) if you want to run the cable into the ceiling.

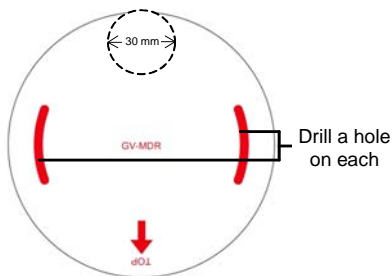

3. Insert the screw anchors.
4. Unscrew the housing cover using the supplied torx wrench.
5. Secure the camera body to the ceiling with the self-tapping screws.



6. Install the cable connector to waterproof the cable. You should have 5 parts:



- A. Prepare an Ethernet cable with the RJ-45 connector on one end only.



- B. Connect the Ethernet cable to the camera cable.  
C. Paste the sticker to the camera cable and slide in all the components as shown below.



- D. Move all the components toward the RJ-45 connector, fit item 4 to item 2, secure item 3 to the camera cable and finally secure item 5 to item 2 tightly.



**IMPORTANT:** Item 5 must be secured tightly to waterproof the cable.

7. Access the live view. See 24.2 *Accessing the Live View* in the *Quick Start Guide*.
8. Adjust the angles based on the live view.

### Pan Adjustment



### Tilt Adjustment

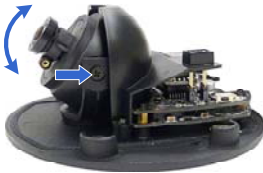

### Rotational Adjustment



9. Adjust image clarity using the GV-IP Device Utility program. For details, see *24.3 Adjusting Image Clarity* in the *Quick Start Guide*.
10. Insert a memory card (SD/SDHC, version 2.0 only, Class 10) into the memory card slot.
11. Replace the silica gel bag.
12. Secure the housing cover using the supplied torx wrench.
13. Optionally conceal the cable opening with the supplied cable stopper.





## 5.4 Connecting the Camera

Refer to the wire definition and illustrations below to connect the power and network.

### 5.4.1 Wire Definition

#### GV-MDR Series

Power and network connectivity is provided through a PoE cable.

Wire Color	Definition
Gray	PoE, Ethernet

### 5.4.2 Power and Network Connection

Use one of the following methods to power on and connect your camera to network:

- **Wired connection with PoE:** Use a Power over Ethernet (PoE) adapter to connect the camera to the network, and the power will be provided at the same time.
- **Wired connection with network cable (GV-MFD Series only):** Connect the camera with a standard network cable and use the power adapter to supply power. See *Powering On the Camera* below to assemble the terminal block with power adapter.
- **Wireless connection (GV-MFD1501 Series / 2401 Series / 2501 Series / 3401 Series / 5301 Series only):** Connect the camera with a GV-WiFi Adapter (optional accessory) and use the power adapter to supply power.

### 5.4.3 Vehicle Installation

To install the **Mini Fixed Rugged Dome** on a vehicle, clip the ferrite core to the camera cable. The ferrite core must be attached as close as possible to the camera with the maximum distance of 15 cm.

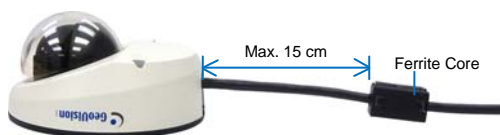

## 6. Target Mini Fixed Dome

### 6.1 Packing List

- Target Mini Fixed Dome
- Screw x 2
- Screw Anchor x 2
- Focus Adjustment Clip or Ring
- GV-IPCAM Software DVD
- GV-NVR Software DVD
- Warranty Card

**Note:** The power adapter can be purchased upon request.

## 6.2 Overview

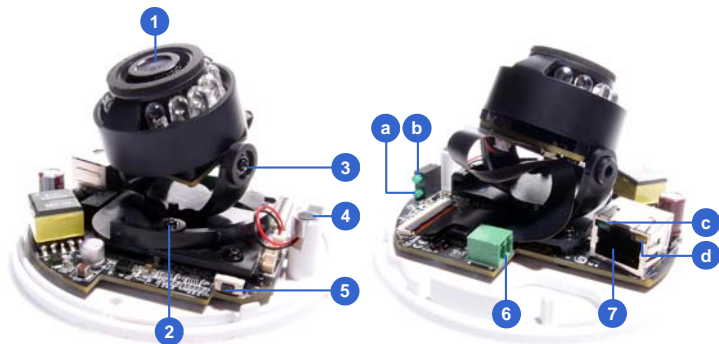

No.	Name	Description
1	Lens	Receives image inputs.
2	Pan Screw	Loosens the screw to adjust pan angle.
3	Tilt Screw	Loosens the screw to adjust tilt angle.
4	Microphone	Receives sound.
5	Default Button	Resets the camera to default settings. See 27. <i>Restoring to Default Settings.</i>
6	DC 12V Port	Connects to power.
7	LAN / PoE	Connects to a 10/100 Ethernet or PoE.
a	Status	Turns on (green) when the system is ready.
b	Power	Turns on (green) when power is on.
c	Link	Turns on (green) when the network is connected.
d	ACT	Turns on (orange) when data are being transmitted.

## 6.3 Installation

The Target Mini Fixed Dome can be installed on the wall or the ceiling. Before installing the camera, make sure the installing site is shielded from rain and moisture.

1. Open the housing cover by turning.



2. Place the camera where you want to install it and make 2 marks on the ceiling or the wall for screw anchors. If you want to run the cables inside the ceiling or the wall, make a round mark with a diameter of 2.5 cm.

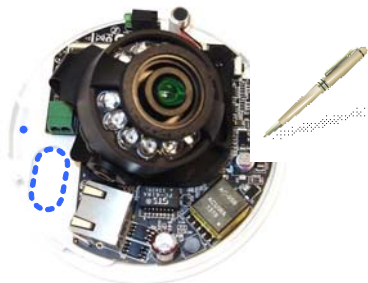

3. Drill the marks and insert the screw anchors.

4. Thread the power and / or network cable(s) through the oval-shaped hole or the cable opening on the side, and connect the camera to network and power. For details, see *6.4 Connecting the Camera*.

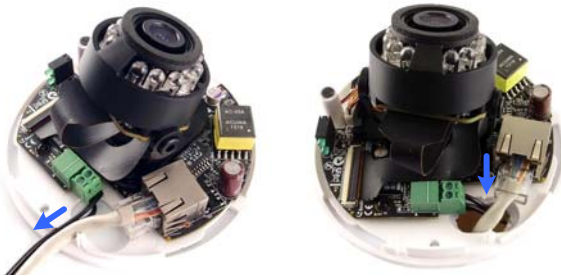

5. Secure the Target Mini Fixed Dome to the ceiling or the wall with the self-tapping screws.
6. Access the live view. For details, see *24.2 Accessing the Live View* in the *Quick Start Guide*.
7. Loosen the tilt screw and pan screw, adjust the angles based on the live view as needed, and tighten the screws again.



8. Adjust image clarity using the GV-IP Device Utility program. For details, see *24.3 Adjusting Image Clarity* in the *Quick Start Guide*.
9. Place the housing cover back and turn to secure it.

## 6.4 Connecting the Camera



1. Connect power using one of the following methods:
  - Plug the power adapter to the 12V terminal block. The power adapter is an optional device. For detail, see *Options* in the *GV-IPCAM Hardware Manual* for Target Mini Fixed Dome on the Software DVD.
  - Use the Power over Ethernet (PoE) function and the power will be provided over the network cable.

The power and status LEDs shall turn on (green).

2. Use a standard network cable to connect the camera to your network.
3. You are ready to access the live view, adjust the image clarity and configure the basics. See 24. *Accessing the Camera* in the *Quick Start Guide*.

## 7. Target Mini Fixed Rugged Dome

### 7.1 Packing List

- Target Mini Fixed Rugged Dome
- Screw x 2
- Screw Anchor x 2
- Focus Adjustment Ring
- Installation Sticker
- Conduit Converter
- RJ-45 Connector
- Waterproof Rubber Set (for RJ45 and DC12V)
- Torx Wrench
- Silica Gel Bag x 2
- Adhesive Tape x 2
- Concave Hexagon Wrench
- Ruler
- Screw for Conduit Converter x 2
- GV-IPCAM Software DVD
- GV-NVR Software DVD
- Warranty Card



**Note:**

1. Power adapter can be purchased upon request.
2. You can choose to run the wires through a conduit pipe. After you have threaded all the wires, install the supplied conduit converter with a PG21 conduit connector and a self-prepared conduit pipe (of 1/2", 3/4" or 1") to the camera. Do not use a 1/2" pipe if you use the power adapter for power supply because the adapter cannot be threaded through. A plastic PG21 conduit connector for 1/2" pipe can be purchased upon request.



## 7.2 Overview

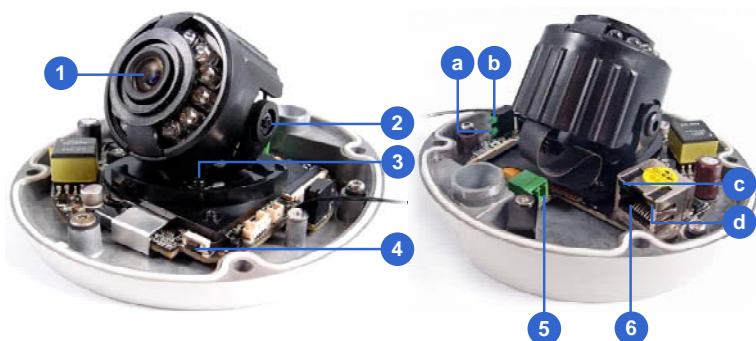

No.	Name	Description
1	Lens	Receives image inputs.
2	Pan Screw	Loosens the screw to adjust pan angle.
3	Tilt Screw	Loosens the screw to adjust tilt angle.
4	Default Button	Resets the camera to default settings. See 27. <i>Restoring to Default Settings.</i>
5	DC 12V Port	Connects to power.
6	LAN / PoE	Connects to a 10/100 Ethernet or PoE.
a	Status	Turns on (green) when the system is ready.
b	Power	Turns on (green) when power is on.
c	Link	Turns on (green) when the network is connected.
d	ACT	Turns on (orange) when data are being transmitted.

## 7.3 Installation

The Target Mini Fixed Rugged Dome can be installed on the wall or ceiling. You must use the supplied waterproof rubber set to waterproof the cable.

1. Paste the installation sticker where you want to install, and drill two holes that are at a diagonal. To run the cables inside the wall or ceiling, drill a larger opening as shown below.

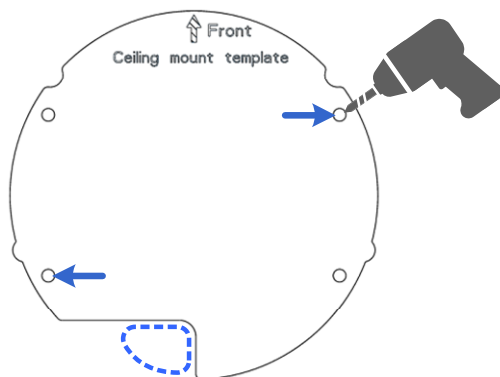

2. Insert the supplied screw anchors into the two drilled holes.
3. Open the camera's housing cover using the supplied torx wrench.



4. Unscrew the three screws as indicated below. A back plate can be separated from the bottom.

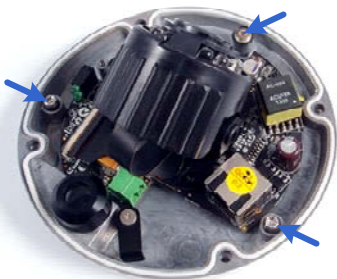

5. Use the 2 supplied screws to secure the back plate onto the ceiling or the wall where the screw anchors were inserted.



6. Prepare an Ethernet cable with the RJ-45 connector on one end only.
7. Remove the waterproof cap from the cable opening and thread the power and / or network cable(s) through the opening.

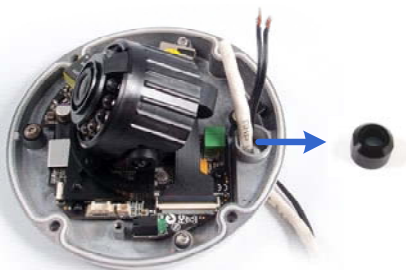

8. Install the supplied waterproof rubber set onto the cable(s). The rubber set has two parts. Item 1 comes in two types.

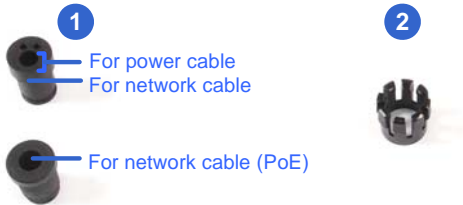

- A. Slide the waterproof rubber set, and the waterproof cap you previously removed through the cable(s) as shown below.



- B. Connect the supplied RJ-45 connector to the Ethernet cable.  
C. If you are using a power adapter, insert the striped wire to the left pin (+) and the other wire to the right pin (-).

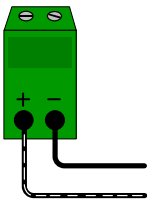

- D. Fit item 1 to item 2, and insert them in the cable opening. Use the supplied ruler to make sure the length of the cable(s) from the bottom of the opening to the end of the cable is under 10 cm.



- E. Cap the cable opening with the waterproof cap. Use the supplied concave hexagon wrench to tighten.



9. Thread the cable(s) under the black cable holder. You can loosen the screw on the cable holder if needed.



10. Connect the camera to network and power. For details, see 7.4 *Connecting the Camera*.
11. Secure the camera to the back plate by tightening the three screws as shown in Step 4.
12. Access the live view. For details, see 24.2 *Accessing the Live View*.
13. Adjust image clarity using the GV-IP Device Utility program. For details, see 24.3 *Adjusting Image Clarity*.
14. Loosen the tilt screw and pan screw, adjust the angles based on the live view as needed, and tighten the screws again.



15. Attach the silica gel bag to the place indicated below, and secure the housing cover using the torx wrench.

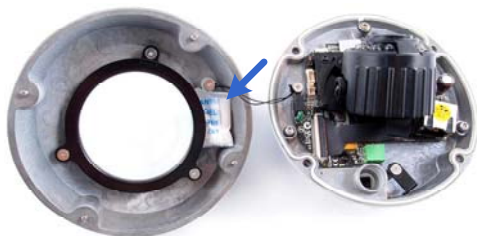



## 7.4 Connecting the Camera

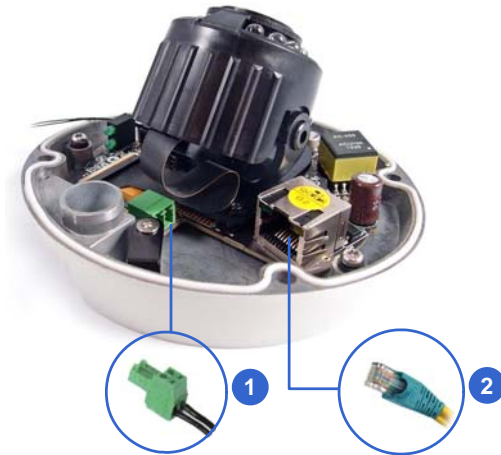

1. Connect power using one of the following methods:
  - Plug the power adapter to the 12V terminal block. The power adapter is an optional device. For detail, see *Options, GV-IPCAM Hardware Manual* for Target Mini Fixed Rugged Dome on the Software DVD.
  - Use the Power over Ethernet (PoE) function and the power will be provided over the network cable.

The power and status LEDs shall turn on (green).
2. Use a standard network cable to connect the camera to your network.
3. You are ready to access the live view, adjust the image clarity and configure the basics. See 24. *Accessing the Camera* in the *Quick Start Guide*.

## 8. Bullet Camera (Part I)

### 8.1 Packing List

- Bullet Camera
- Self Tapping Screw x 3
- Plastic Screw Anchor x 3
- Torx Wrench x 2
- Sun-Shield Cover Kit (Sun-Shield Cover, Philips Head Screws x 2, Plastic Screw Spacer x 2 and Hexagon Screw x 2)
- Silica Gel Bag x 2
- 2-Pin Terminal Block
- Power Adapter
- GV-IPCAM Software DVD
- GV-NVR Software DVD
- Warranty Card

**Note:** The power adapter can be excluded upon request.

## 8.2 Overview

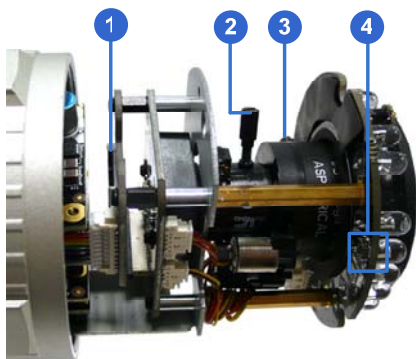

No.	Name	Description
1	Memory Card Slot	Receives a micro SD card (SD/SDHC, version 2.0 only, Class 10).
2	Zoom Screw	Holds the zoom lens in place.
3	Focus Screw	Holds the focus lens in place
4	Default Button	Resets the camera to default settings. See <i>27. Restoring to Default Settings</i> later in the <i>Quick Start Guide</i> .

## 8.3 Installation

The Bullet Camera is designed for outdoor use and can be mounted on ceiling and wall.

1. Slide the cable clamp to the camera base.

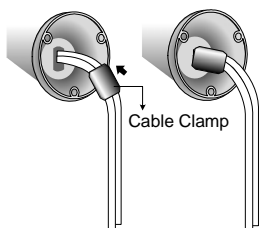

2. Install the Bullet Camera to the wall / ceiling.



3. Remove the protection sticker from the camera's cover.
4. Connect the power, network and other cables to the camera. See *8.4 Connecting the Camera* in the *Quick Start Guide*.
5. Access the live view. See *24.2 Accessing the Live View* in the *Quick Start Guide*.
6. Adjust the angles of the camera body based on the live view. Three shafts can be adjusted. For details, see *8.3.1 Adjusting the Angles* in the *Quick Start Guide*.

7. Loosen the camera's cover, adjust the lens and focus, and insert a micro SD card (SD/SDHC, version 2.0 only, Class 10) into the memory card slot. See *8.3.2 Adjusting Lens and Inserting a Memory Card* in the *Quick Start Guide*.
8. Fasten the camera's cover.
9. Install the sun-shield cover to the Bullet Camera. For details, see *8.3.3 Installing the Sun-Shield Cover* in the *Quick Start Guide*.

## 8.3.1 Adjusting the Angles

The Bullet Camera is designed to be adjustable in three shafts.

**Tip:** The three shafts are designed to offer easy and flexible ceiling / wall mount installation.

### First Shaft

You can adjust the camera body by 360 degrees to the right or the left.

1. Unscrew the panning lock screw with the torx wrench.

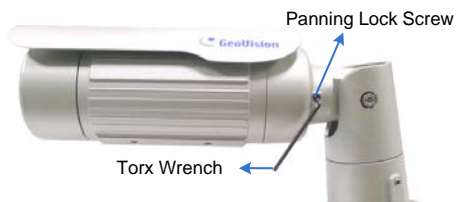

2. Adjust the angle of camera body to the right or the left, and fasten the panning lock screw.



## Second Shaft

You can adjust the camera body up and down by 90, 112.5, 135, 157.5 or 180 degrees by using the gears inside the camera body and the camera base.

1. Unscrew the tilting lock screw with the torx wrench.



2. Hold the camera body, and move the camera base to the right to separate the camera gears.

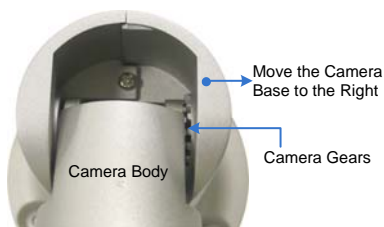

3. Adjust the angle of camera body to 90, 112.5, 135, 157.5 or 180 degrees. Then move the camera base to the left to combine the gears.



4. Fasten the tilting lock screw.

### Third Shaft

You can adjust the camera base by 360 degrees.

1. Unscrew the base fixing screw with the torx wrench.



2. Adjust the angle of camera base, and fasten the base fixing screw.





### 8.3.2 Adjusting Lens and Inserting a Memory Card

To adjust the camera's lens to produce a clear image and insert a micro SD card (SD/SDHC, version 2.0 only, Class 10) into the memory card slot, follow the steps below.

1. Loosen the camera's cover. For GV-BL2510-E / 5310-E, loosen the camera's cover and the screw as indicated below.

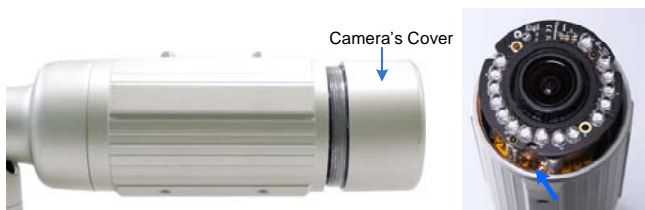

2. To adjust for image clarity, follow the steps below.

- For **models with zoom and focus screws**, pull out the camera and remove the silica gel bag to access its focus and zoom screws. Use GV-IP Device Utility to help you. For details, see 22.3 *Adjusting Image Clarity* in the *Quick Start Guide*.



- For **motorized varifocal lens models**, adjust for image clarity through the Web interface. For details, see *Zoom, Focus Change, and Focus Mode settings, The Control Panel of the Live View Window, Accessing the Camera Chapter, GV-IPCAM Firmware Manual* on Software DVD.

3. To insert a memory card, follow the steps below.

A. Loosen the fixing screw.

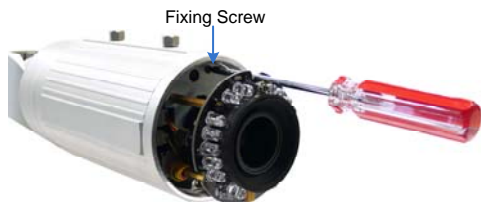

B. Slightly pull out the camera module.

C. Insert a micro SD card (SD/SDHC, version 2.0 only, Class 10) into the memory card slot.

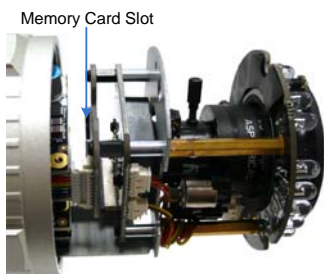

D. Push the camera module back and fasten the fixing screw.

4. Insert a new silica gel bag to the camera module.



All Bullet Camera except GV-BL2510-E/5310-E



GV-BL2510-E/5310-E

### 8.3.3 Inserting the Sun-Shield Cover

After setting up the Bullet Camera, now you can install the sun-shield cover to the camera.

1. Fasten the hexagon screws either on top or below the camera.



2. Put the sun-shield cover on top of hexagon screws. Make sure to aim the rear hexagon screw at the edge of the sun-shield cover's aperture for optimal sun-shield performance.



3. Fasten the Philips head screws with the plastic screw spacers.

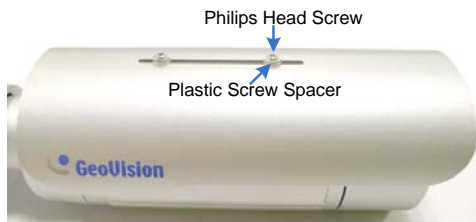

## 8.4 Connecting the Camera

Connect your Bullet Camera to power, network and the cables needed.

### 8.4.1 Wire Definition

The cable of the Bullet Camera is illustrated and defined below:

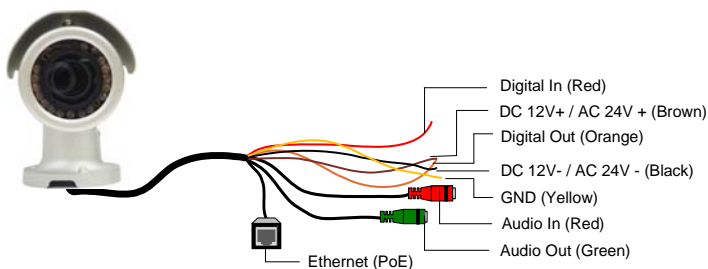

No.	Wire Color	Definition
1	Red	Digital In
2	Brown	DC 12V+ / AC 24V+
3	Orange	Digital Out
4	Black	DC 12V- / AC 24V-
5	Yellow	Ground
6	Red RCA	Audio in
7	Green RCA	Audio out

Note that the Audio In and Out connectors may also come as terminal blocks:

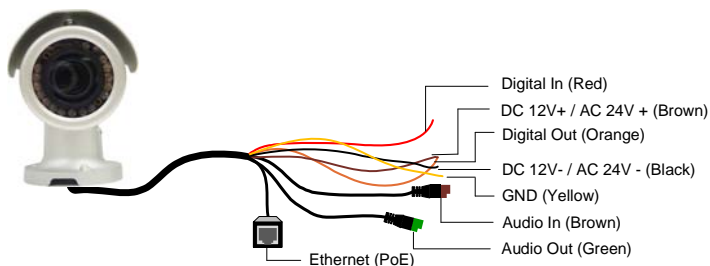

No.	Wire Color	Definition
1	Red	Digital In
2	Brown	DC 12V+ / AC 24V+
3	Orange	Digital Out
4	Black	DC 12V- / AC 24V-
5	Yellow	Ground
6	Brown terminal block	Audio in
7	Green terminal block	Audio out

## 8.4.2 Connecting the Power Cable

Use one of the following methods to supply power to the camera. Note that **GV-BL2510-E / 5310-E** do not support PoE.

- Use a Power over Ethernet (PoE) adapter to connect the camera to the network, and the power will be provided at the same time.
  - Plug the power adaptor to the terminal block as shown below.
1. Insert the black wire of the Bullet Camera to the left pin (+) and the brown wire to the right pin (-).

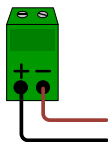

2. Connect the DC 12V Power Adaptor to the Terminal Block.



## 9. Bullet Camera (Part II)

### 9.1 Packing List

- Bullet Camera
- Self Tapping Screw x 3
- Plastic Screw Anchor x 3
- Torx Wrench x 3
- Sun-Shield Cover Kit (Sun-Shield Cover, Philips Head Screw x 2, Plastic Screw Spacer x 2, and Hexagon Screw x 2)
- Silica Gel Bag x 2
- 2-Pin Terminal Block
- 3-Pin Terminal Block
- Power Adapter
- Installation Sticker
- Ruler
- Stand Kit (Conduit Converter, PG21 Conduit Connector, RJ-45 Connector, M3 Screw x 2, Cable Tie)
- Mounting Kit (M4 Screw x 3, Nut x 3, Plate x 3)
- GV-IPCAM Software DVD
- GV-NVR Software DVD
- Warranty Card

**Note:**

1. The power adapter can be excluded upon request.
2. The Mounting Kit is used for wall corner and pole installations using GV-Mount300 / 310 / 400 / 410 (optional). For details, see *GV-Mount Accessories Installation Guide* on the Software DVD.



## 9.2 Overview

Twist off the camera cover to access the following:

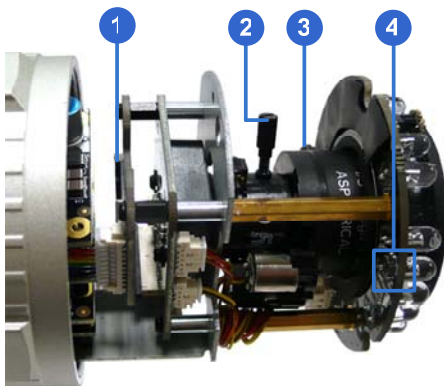

No.	Name	Description
1	Memory Card Slot	Receives a micro SD card (SD/SDHC, version 2.0 only, Class 10).
2	Zoom Screw	Holds the zoom lens in place.
3	Focus Screw	Holds the focus lens in place
4	Default Button	Resets the camera to default settings. See 27. <i>Restoring to Default Settings</i> later in the <i>Quick Start Guide</i> .

To access the following interface, remove the camera base using the supplied torx wrench.



No.	Name	Description
1	LAN / PoE	Connects to a 10/100 Ethernet or PoE.
2	Audio In	Connects a microphone for audio input.
3	Audio Out	Connects a speaker for audio output.
4	I/O Terminal Block	Connects to I/O devices. For details, see <i>I/O Terminal, 9.5 Connecting the Camera.</i>
5	DC 12V Port	Connects to power.

## 9.3 Installation

Follow the steps below to install the Bullet Camera.

1. Paste the supplied sticker to the ceiling/wall. For wall installations, make sure the arrow on the sticker points toward the ceiling.

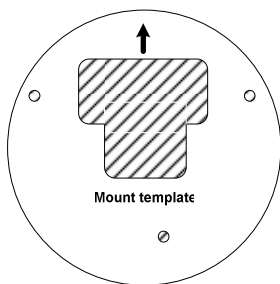

2. Drill the shaded area, and insert the screw anchor into the three holes.
3. Loosen the indicated screws with the supplied torx wrench to remove the base.



4. Loosen the indicated screws and remove the back plate.



**Back Plate**

5. Align and secure the black plate to the wall/ceiling with the supplied self-tapping screws.



- To use a pipe (optional), install the conduit converter using the supplied M3 screws.



**IMPORTANT:** For GV-BL2511-E / 5311-E connected with a power adapter, only install the conduit converter to the indicated exit.

- Install the Ethernet cable.
  - Twist off and remove the cable seal and the conduit connector.

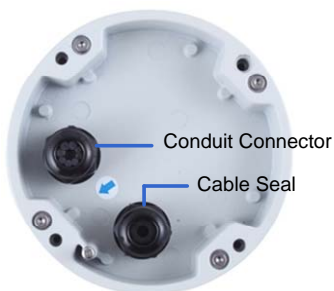

2. Thread an Ethernet cable (with no RJ-45 connector on one end) from the back panel through the conduit converter (optionally installed at step 6) and then through the cable seal.



**IMPORTANT:** Use the supplied ruler and leave about 10 cm of the Ethernet cable between the connector and the cable seal.

3. Re-install the cable seal. Make sure it is installed tightly to waterproof the camera.
- 
8. Thread wires into the camera.
    - A. Disintegrate the removed conduit connector. You should have 4 parts:



- B. Remove the terminal block from the supplied power adapter.

- C. Optionally thread audio wires, adapter wires, and I/O wires through the conduit converter and then through part 1, 2, 3, and 4 of the conduit connector.

**Tip:** To make the threading easier, it is advised to thread the wires in the order described here.

For part 2, there are 8 holes each labeled with its diameter. Remove the plugs and push the wires to the corresponding hole listed below:

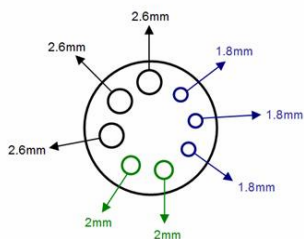

2.6 mm: Audio

2 mm: DC12V / AC24V

1.8 mm: DIDO

**IMPORTANT:**

1. Use the supplied ruler and leave about 10 cm of audio, power, and I/O wires between their connectors and the cable seal.
2. The plugs are used to prevent water from entering the camera housing. Keep the unused holes plugged and save the removed plugs for future use.
3. Only thread the wires through their designated holes on the conduit connector to make sure the wires are properly sealed.

9. Install the base to the back plate on the wall.
10. Connect the wires to the camera.
  - A. Install the terminal blocks to the power adapter and I/O devices. See *Power Connection* and *I/O Device Connections* in 9.5 *Connecting the Camera*.
  - B. Install the supplied RJ-45 connector to the Ethernet cable.
  - C. Plug all the connectors to the camera panel.
11. Tie the wires with the supplied cable tie and re-install the base to the camera. You may need to rotate the base for the wires to fit.





12. Access the live view. For details, see *24.2 Accessing the Live View* in the *Quick Start Guide*.
13. Adjust the angles of the camera based on the live view. Three shafts can be adjusted. See *8.3.1 Adjusting the Angles*.
14. To adjust the focus and insert a micro SD card (SD/SDHC, version 2.0, Class 10), see *8.3.2 Adjusting Lens and Inserting a Memory Card*.
15. Install the sun-shield cover. For details, see *8.3.3 Installing the Sun-Shield Cover*.

## 9.4 Connecting the Camera

### Power Connection

Use one of the following methods to supply power to the camera. Note that **GV-BL2511-E / 5311-E** do not support PoE.

- Use a Power over Ethernet (PoE) adapter to connect the camera to the network, and the power will be provided at the same time.
- Plug the power adaptor to the terminal block as shown below. For all models (except GV-BL2511-E / 5311-E), insert the striped wire to the left pin (+); for GV-BL2511-E / 5311-E, insert the striped wire to the right pin (-).

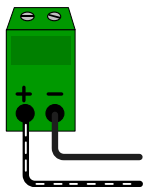

*All Models except GV-BL2511-E / 5311-E*

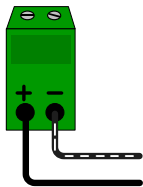

*GV-BL2511-E / 5311-E*

## I/O Device Connection

The camera supports one digital input and one digital output of dry contact.

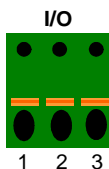

Pin	Function
1	Digital Output
2	GND
3	Digital Input

For details on how to enable an installed I/O device, see *I/O Settings*, *Administrator Mode* Chapter, *GV-IPCAM Firmware Manual* on the Software DVD.

## 10. Bullet Camera (Part III)

The information in this chapter applies to **GV-BL3700 / GV-BL5700**.

### 10.1 Packing List

- H.265 Bullet Camera
- Sun-shield Cover
- Screw for Sun-shield Cover x 2
- Washer x 2
- Screw for Supporting Rack x 3
- Screw Anchor x 3
- Silica Gel Bag x 2
- Screw for Mounting Kit x 3
- Nut for Mounting Kit x 3
- Hex Wrench
- RJ-45 Connector x 2
- GV-IPCAM Software DVD
- GV- Software DVD
- Warranty Card

**Note:** The Mounting Kit is used for wall corner and pole installations using GV-Mount300 / 310 / 400 / 410 (optional). For details, see *GV-Mount Accessories Installation Guide* on the Software DVD.

## 10.2 Overview

Twist off the camera cover to access the following:

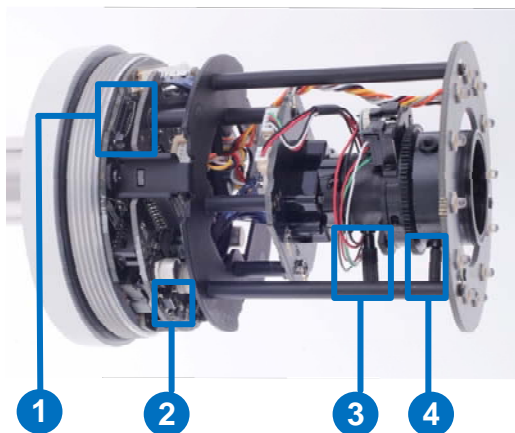

No.	Name	Description
1.	Memory Card Slot	Receives a micro SD card (SD/SDHC/SDXC, Class 10).
2.	Default Button	Resets the camera to default settings. For details, see 27. <i>Restoring to Default Settings</i> later in the <i>Quick Start Guide</i> .
3.	Focus Screw	Holds the focus lens in place
4.	Zoom Screw	Holds the zoom lens in place.

## 10.3 Installation

You can install the camera to the ceiling or wall. Follow the steps below.

1. Unscrew the camera body, remove the sun-shield mount, and loosen the camera cover from the camera.

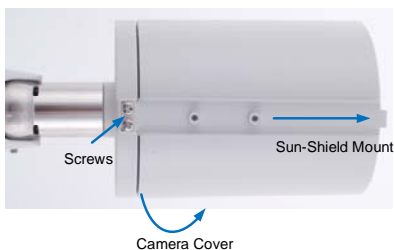

2. Insert a micro SD card (SD/SDHC/SDXC, Class 10) into the card slot.
3. Tape two silica gel bags to the camera module.

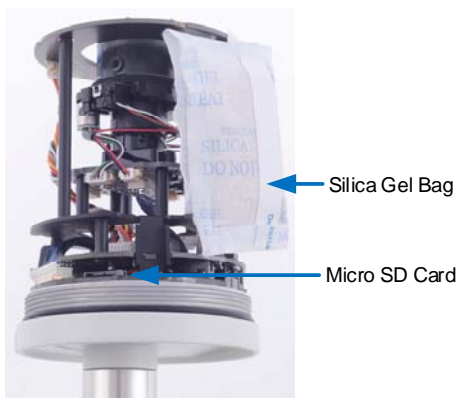

- Secure the camera cover, fasten the sun-shield mount, and screw the camera body.

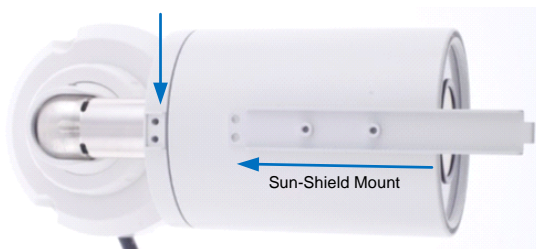

- Slide the sun-shield cover onto the top of the camera. Adjust the position of the cover before fully securing the cover with the washer and the screw.



6. Thread the Ethernet cable into the conduit connector.

A. Remove the plug from the conduit connector.



B. Disintegrate the removed conduit connector. Thread the Ethernet cable through the 3 parts.

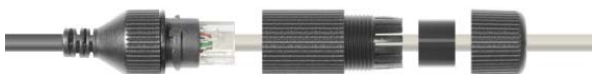

C. Assemble the conduit connector.



**Note:** If you can't plug the self-prepared RJ-45 connector into the jack of the conduit, it is suggested to use the supplied RJ-45 connector.



7. Install the camera to the wall or ceiling using the screw anchors and screws for supporting rack.



**IMPORTANT:** To avoid waterproofing failures, the top of the camera must be facing upward for wall mount.

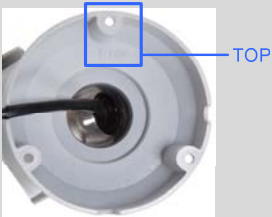

8. Connect the wires and cable connector to the camera. See *10.4 Connecting the Camera*.
9. Access the live view. For details, see *3.1. Accessing the Live View, GV-IPCam Firmware Manual*.
10. Adjust angles of the camera body based on the live view.

### 10.3.1 Adjusting the Angles

The GV-BL3700 / 5700 is designed to be adjustable in two shafts for easy and flexible installation.

#### First Shaft

You can adjust the camera base by 360°.

1. Unscrew the base fixing screw with the hex wrench.



2. Adjust the angle of camera base, and fasten the base fixing screw with the hex wrench.



### Second Shaft

You can adjust the camera body to the desired angle by tilting the camera module.

1. Unscrew the tilting lock screw with the hex wrench.



2. Adjust the angle of camera body to the desired angle.



3. Fasten the tilting lock screw.

### 10.3.2 Adjusting Lens

To adjust the camera's zoom and focus, follow the steps below.

1. Loosen the camera's cover.
2. To adjust for image clarity by adjusting the focus and zoom screws. For details, see *2.2 Adjusting Image Clarity, GV-IPCAM Firmware Manual*.

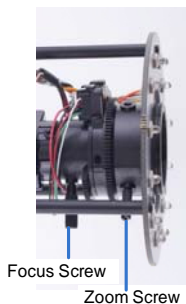

**IMPORTANT:** See *Note for Silica Gel Bags* at the beginning of the Quick Start Guide.

## 10.4 Connecting the Camera

### 10.4.1 Wire Definition

The **4-Pin terminal block** provides connections for 1 sensor input and 1 sensor output. The **5-Pin terminal block** provides power input, 1 audio input and 1 audio output. The wires are illustrated and defined below:

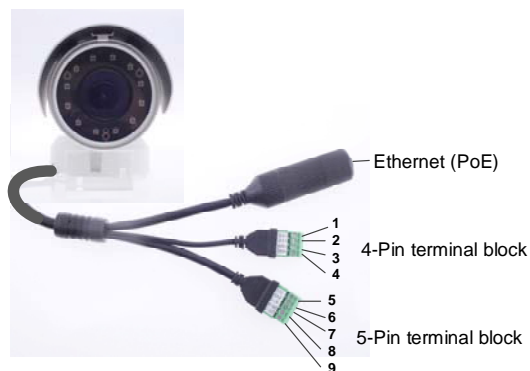

No.	Wire Name	Definition	
1.	4-pin terminal block	DI -	Digital In -
2.		DI +	Digital in +
3.		DO -	Digital Out -
4.		DO+	Digital Out +
5.	5-pin terminal block	12V	12 V -
6.		GND	DC 12V +
7.		L-IN	Audio in
8.		A GND	Audio Ground
9.		L-OUT	Audio out
Wire	Definition		
RJ-45	Ethernet / PoE (IEEE 802.3af)		

## 10.4.2 Power Connection

Use one of the following methods to supply power to the camera.

- Use a Power over Ethernet (PoE) adapter to connect the camera to the network, and the power will be provided at the same time.
- Connect the wires of your power adapter to the DC 12V+ and DC 12V- pins of the 5-pin terminal block.



# 11. Ultra Bullet Camera

## 11.1 Packing List

- Ultra Bullet Camera (with Waterproof or Non-Waterproof LAN connector)
- Camera Stand
- Black Rubber
- Self Tapping Screw x 3
- Plastic Screw Anchor x 3
- Torx Wrench
- Sun-Shield Cover Kit (Sun-Shield Cover, Philips Head Screw x 2, Plastic Screw Spacer x 2 and Hexagon Screw x 2)
- Cable connector (for waterproof LAN connector only)
- Silica Gel Bag x 2
- 2-Pin Terminal Block
- Data cable
- Power Adapter
- GV-IPCAM Software DVD
- GV-NVR Software DVD
- Warranty Card

**Note:** The power adapter can be excluded upon request.

## 11.2 Overview



No.	Name	Description
1	Power & I/O Connector	Connects to the data cable. For details, see <i>11.4 Connecting the Camera</i> in the <i>Quick Start Guide</i> .
2	Default Button	Resets the camera to default settings. See <i>27. Restoring to Default Settings</i> in the <i>Quick Start Guide</i> .
3	LAN / PoE Cable	Connects to a 10/100 Ethernet or PoE.
4	Memory Card Slot	Receives a micro SD card (SD/SDHC, version 2.0 only, Class 10).
5	Silica gel bag	Desiccant that keeps the camera housing dry.



## LAN Connector

The Ultra Bullet Camera provides two connector types. Select an option based on your installation environment.

- **Option 1 (Waterproof)**

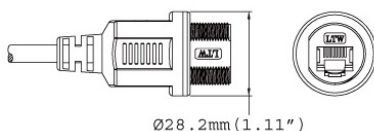

To waterproof the cable, install the supplied cable connector. See *11.4.1 Waterproofing the Cable* in the *Quick Start Guide*.

- **Option 2 (Smaller and non-waterproof)**

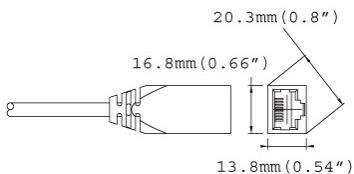

## 11.3 Installation

You can install the camera to the ceiling or wall. Follow the steps below.

1. Optionally insert a micro SD card to the camera.
  - A. Unscrew and open the back panel with the supplied torx wrench.



- B. Insert a micro SD card (SD/SDHC, version 2.0 only, Class 10) into the card slot and replace the silica gel bag.
  - C. Secure the back cover with the supplied torx wrench.
2. Install the sun-shield cover to the camera.
    - A. Fasten the hexagon screw(s) on the top of the camera.



**IMPORTANT:** To avoid waterproofing failures, do not open the front cover of the camera and the screw on the camera body. Ssee *Note for Waterproofing Failures* at the beginning of the Quick Start Guide.

- B. Put the sun-shield cover on the top of the camera. For optimal sun-shield performance, make sure the rear hexagon screw is at the end of the opening.



**IMPORTANT:** The GeoVision logo on the sun-shield cover should be closer to the front of the camera.

- C. Fasten the Philips head screws with the plastic screw spacers to mount the sun-shield cover onto the camera.
- Ceiling Mount: Fasten one Philips head screw to the top of the camera.
  - Wall Mount: Fasten two Philips head screws to the top of the camera.

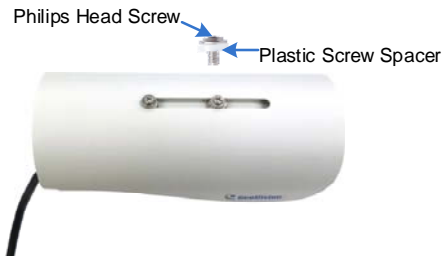

3. Install the camera stand.

- A. Ceiling Mount: Secure the black rubber and the camera stand to the other screw hole on the top.
- B. Wall Mount: Secure the black rubber and the camera stand to one of the screw holes on the bottom.



4. Use the screw anchors and self-tapping screws to secure the camera to the wall.



5. Remove the protection sticker from the camera's cover.
6. Connect the wires and cable connector to the camera. See *11.4.1 Waterproofing the Cable* and *11.4.2 Connecting the Camera*.
7. Access the live view. For details, see *2.1 Accessing the Live View, GV-IPCAM Firmware Manual*.
8. Adjust angles of the camera body based on the live view.
9. For varifocal models (GV-UBL1211 / 1511 / 2411 / 2511 / 3411), adjust the focus. For details, see *3.2.2 The Control Panel of the Live View Window, GV-IPCAM Firmware Manual*.

## 11.4 Connecting the Camera

### 11.4.1 Waterproofing the Cable

Waterproof the cable of the LAN connector, using the supplied cable connector. The cable connector can be dissembled into 5 parts.

#### [LAN Connector]

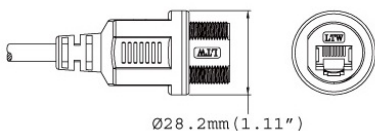

#### [Cable Connector]



1. Cut off the RJ-45 connector on one end of the Ethernet cable.



2. Connect the Ethernet cable to the LAN / PoE connector.

- Slide the components through the Ethernet cable as shown below.



- Paste the item 1 sticker to item 2.
- Move all the components toward the LAN connector, fit item 4 to item 2, secure item 3 to the LAN connector (Item A) and finally secure item 5 to item 2 tightly.



**IMPORTANT:** Item 5 must be secured tightly to waterproof the LAN connector.

- Prepare an RJ-45 connector, reconnect the RJ-45 connector to the cable, and then connect the camera to network.

## 11.4.2 Wire Definition

The supplied 4-pin data cable provides connections for power, ground, 1 sensor input and 1 alarm output. The wires are defined below:



No.	Wire Color	Definition
1	Red	DC 5V
2	Green	Digital In
3	Blue	Digital Out
4	Black	Ground



### 11.4.3 Power Connection

Connect the camera to power using one of the following methods:

- Use a Power over Ethernet (PoE) adapter to connect the camera to the network, and the power will be provided at the same time.
- Plug the power adaptor to the terminal block as shown below.
  1. Insert the black wire of the data cable to the left pin (-) and the red wire to the right pin (+).

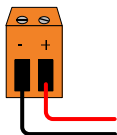

2. Connect the DC 5V power adaptor to the terminal block.



## 12. Target Bullet Camera (Part I)

### 12.1 Packing List

- Target Bullet Camera
- Sun-Shield Cover
- Silica Gel Tape x 2
- Supporting Rack
- Screw for Supporting Rack x 3
- Screw Anchor x 3
- Screw for Sun-shield Cover
- Washer
- Terminal Block
- GV-IPCAM Software DVD
- GV-NVR Software DVD
- Warranty Card

**Note:** Power adapter can be purchased upon request.

## 12.2 Overview



No.	Name	Description
1	Power Connector	Connects to the data cable. For details, see <i>12.4.1 Connecting the Camera</i> .
2	Default Button	Resets the camera to default settings. See <i>27. Restoring to Default Settings</i> in the <i>Quick Start Guide</i> .

**IMPORTANT:** The silica gel loses its effectiveness when the camera is opened. If you open the camera to access the load default button, replace the silica gel tape by taping the new silica gel tape to the inside of the camera cover. Make sure you conceal the silica gel tape in the camera within two minutes of exposing to the open air.



## 12.3 Installation

You can install the camera to the ceiling or wall. Follow the steps below.

**IMPORTANT:** To avoid foggy live view, replace Silica Gel Tape prior to installation and use waterproof tape to seal the RJ-45 connector.

1. Slide the sun-shield cover onto the top of the camera.



**Note:** The GeoVision logo on the sun-shield cover should be closer to the front of the camera.

2. Line up the screw hole on the camera with the opening on the sun-shield cover.



3. Ceiling Mount: Secure the supporting rack to the opening on the sun-shield cover.



4. Wall Mount:
  - A. Insert and tighten the supplied screw on the sun-shield cover.
  - B. Secure the supporting rack to the bottom.



**IMPORTANT:** To avoid waterproofing failures, do not open the screw on the camera body (see *Note for Bullet Waterproofing Failures*).

5. Thread the Ethernet cable into the conduit connector. For details, see step 6, *10.3 Installation*.



**Note:** The size of RJ-45 connector must be within 14 mm to plug into the jack of the conduit.

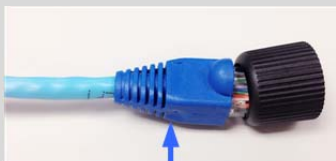

Unfit size of RJ45 Connector

6. Install the camera to the wall or ceiling using the screw anchors and self-tapping screws. You can also stand the camera on a plain surface.



7. Remove the protection sticker from the camera's cover.
8. Connect the wires and cable connector to the camera. See *12.4 Connecting the Camera* in the *Quick Start Guide*.
9. Access the live view. For details, see *24.2. Accessing the Live View*.
10. Adjust angles of the camera body based on the live view.



## 12.4 Connecting the Camera

### 12.4.1 Wire Definition

The data cable provides connections for power, ground and network access. The wires are defined below:



No.	Wire Color	Definition
1	Red	DC 12V
2	Black	Ground
3	Black (thick)	PoE, Ethernet

## 12.4.2 Power Connection

There are two ways to supply power to the camera:

- Use a Power over Ethernet (PoE) adapter to connect the camera to the network, and the power will be provided at the same time.
  - Plug the power adaptor to the terminal block as shown below. The power adaptor is an optional device. For detail, see *Options* in the *GV-IPCAM Hardware Manual* for Target Bullet Camera on the Software DVD.
1. Insert the black wire of the data cable to the left pin (-) and the red wire to the right pin (+).

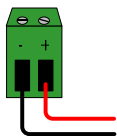

2. Connect the DC 12V power adaptor to the terminal block.



## 13. Target Bullet Camera (Part II)

The information in this chapter applies to **GV-EBL2101**.

### 13.1 Packing List

- Target Bullet Camera
- Sun-Shield Cover



- Silica Gel Bag x2



- Screw for Supporting Rack x 3



- Screw Anchor x 3



- Screw for Sun-shield Cover x 2



- Washer x 2



- RJ45 Connector



- Terminal Block



- Screw for Mounting Kit x 3



- Nut for Mounting Kit x 3



- Hex Wrench



- GV-IPCAM Software DVD

- GV-NVR Software DVD
- Warranty Card

**Note:** Power adapter can be purchased upon request.

## 13.2 Overview



No.	Name	Description
1	Zoom Screw	Holds the zoom lens in place.
2	Focus Screw	Holds the focus lens in place
3	Default Button	Resets the camera to default settings. See 27. <i>Restoring to Factory Default Settings</i> in the <i>Quick Start Guide</i> .

## 13.3 Installation

You can install the camera to the ceiling or wall. Follow the steps below.

1. Replace the Silica Gel Bag.
  - A. Remove the camera cover from the camera.



- B. Loosen the camera's screws and the hexagon pillars as indicated below.



- C. Take out the camera from the camera body



- D. Cut the 2 silica gel bags apart with scissors and place the new silica gel bags at the lower half of the camera body.



2. Secure the 2 hexagon pillars to the upper and lower holes of camera module as indicated below.

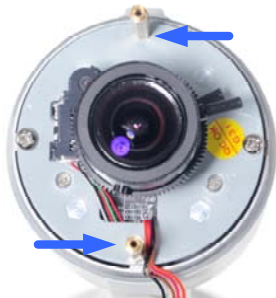

3. Secure the camera cover.
4. Slide the sun-shield cover onto the top of the camera. You can also secure the sun shield cover onto the back of the camera. Adjust the position of the cover before fully securing the cover with the washer and the screw.



**Note:**

1. The GeoVision logo on the sun-shield cover should be closer to the front of the camera.
2. There are two holes for the screws at the back of the camera. You only need to fasten one screw to secure the sun shield cover.



5. Thread the Ethernet cable into the conduit connector. For details, see step 6, *10.3 Installation*.



**Note:** If you can't plug the self-prepared RJ-45 connector into the jack of the conduit, it is suggested to use the supplied RJ-45 connector.

6. Install the camera to the wall or ceiling using the screw anchors and screws for supporting rack.



**IMPORTANT:** To avoid waterproofing failures, the top of the camera must be facing upward for wall mount.

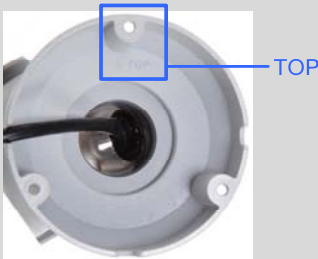

7. Connect the wires and cable connector to the camera. See 13.4 *Connecting the Camera*.
8. Access the live view. For details, see 3.1. *Accessing the Live View, GV-IPCAM Firmware Manual*.
9. Adjust angles of the camera body based on the live view.

## 13.4 Connecting the Camera

### 13.4.1 Wire Definition

The data cable provides connections for power, ground and network access. The wires are defined below:



No.	Wire Color	Definition
1	Red	DC 12V
2	Black	Ground
3	Black (thick)	PoE, Ethernet

### 13.4.2 Power Connection

For details, see [12.4.2 Power Connection](#).

## 14. Vandal Proof IP Dome (Part I)

The information in this chapter applies to **GV-VD120D / 121D / 122D / 123D / 220D / 221D / 222D / 223D / 320D / 321D / 322D / 323D / 1500 / 2400 / 3400**.

### 14.1 Packing List

- Vandal Proof IP Dome
- Screw Anchor x 4



- Ceiling Screw x 4



- T-Cap Screw x 3



- T-Cap x 3



- Focus Adjustment Cap



- Silica Gel Bag x 2
- Torx Wrench



- Blue Screw x 3



- Small Screw Cap x 3



- Plastic Clip x 3



- 2-Pin Terminal Block

- GV-IPCam Software DVD
- Power Adapter
- GV-NVR Software DVD
- Warranty Card

**Note:**

1. Focus Adjustment Cap is only needed and supplied for IK10+ models.
2. The power adapter can be excluded upon request.

## 14.2 Overview

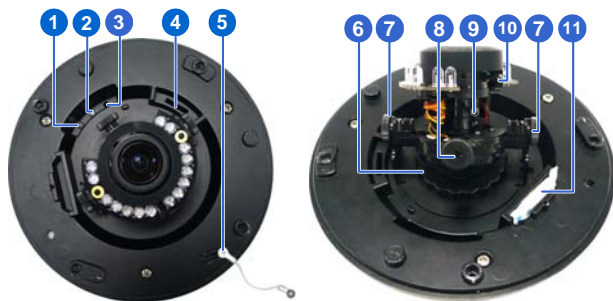

No.	Name	Description
1	Power LED	Turns on (green) when the power is on and turns off when there is no power supply.
2	Status LED	Turns on (green) when the system operates normally and turns off when system error occurs.
3	Default Button	Resets the camera to default settings. See <i>27. Restoring to Default Settings</i> in the <i>Quick Start Guide</i> .
4	Memory Card Slot	Receives a micro SD card (SD/SDHC, version 2.0 only, Class 10) to store recording data.
5	Thread Lock	Locks the housing cover to the camera body to prevent the cover from falling.
6	Pan Disc	Loosens to pan the camera.
7	Tilt Screw	Loosen the screw to tilt the camera.
8	Rotational Screw	Loosens to adjust the camera angle.

No.	Name	Description
9	Zoom Screw	Adjusts the zoom of the camera.
10	Focus Screw	Adjusts the focus of the camera.
11	Silica Gel Bag	Absorbs moisture in the camera body.

## 14.3 Installation

The Vandal Proof IP Dome is designed for outdoors. With the standard package, there are two ways to install the Vandal Proof IP Dome:

**hard-ceiling mount** and **in-ceiling mount**.

**Note:** You can also install the camera:

- on a power box (of the 4" square and double gang type) using the standard package
- to ceilings, wall corners (concave or convex), and poles using optional mounting kits

For details on these installations, see *GV-Mount Accessories Installation Guide* on the Software DVD.



### 14.3.1 Hard-Ceiling Mount



1. Unpack the camera package and take out the camera body.

Unscrew the housing cover



Unscrew thread lock



Unscrew the inner housing



Take out the camera body



2. Mark the position of four screw holes on the desired installation location, and drill holes in the marked locations. Drill the ellipse part if you wish to put the wires through it.



3. Insert the screw anchors to the 4 holes on the ceiling.
4. Secure the back cover to the ceiling with 4 ceiling screws.

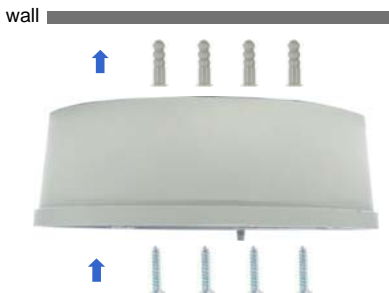

5. Refer to step 1 to secure the camera body with inner housing.
6. Thread the cable through the conduit entry at the side of the back cover. Alternatively pass the wires through the ellipse hole at the bottom of the back cover.
7. Connect the network and power cables to the camera. See *14.4 Connecting the Camera* in the *Quick Start Guide*.
8. Access the live view. See *24.2 Accessing the Live View* in the *Quick Start Guide*.
9. Adjust the camera to a desired angle as illustrated below.

**Tip:** The 3-axis mechanism offers flexible and easy installation.

### Pan Adjustment



### Tilt Adjustment



### Rotational Adjustment



10. Hold the focus adjustment cap on top of the camera view and adjust for image clarity using the GV-IP Device Utility program. For details, see 22.3 *Adjusting Image Clarity* in the *Quick Start Guide*.

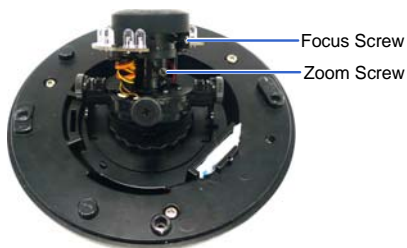

11. Screw on the thread lock as shown in step 1.
12. Replace the silica gel bag, and secure the housing cover.

**Note:** Adjust the black mask inside the housing cover to make sure the camera view is not obscured.

### 14.3.2 In-Ceiling Mount



1. Follow step 1 in the *Hard-Ceiling Mount* section to remove the housing cover, thread lock and back cover, and take out the camera body.
2. Cut out a circle with a diameter of 142 mm on the ceiling.
3. Insert a blue screw to the indicated holes on the camera body.



4. Screw in a plastic clip to the blue screw, hold it with one hand and use a screw driver to rotate the blue screw until the plastic clip moves half way down.

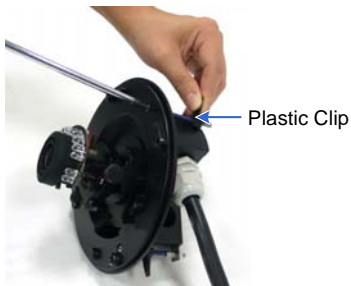

5. Secure a T-cap on top of the blue screw with a small screw cap and a T-cap screw. Do not tighten the small screw cap so that the plastic clip can move down freely.

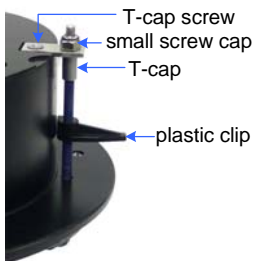

6. Repeat steps 4 and 5 for the other two blue screws.

7. Insert the camera to the ceiling with the plastic screws moved inward.



8. Move the blue screws out and rotate the blue screw with a screw driver until the plastic clip and the bottom of the camera body clamps the ceiling tightly.



9. Connect the network and power cables to the camera. See [14.4 Connecting the Camera](#) in the *Quick Start Guide*.
10. Access the live view. See [24.2 Accessing the Live View](#) in the *Quick Start Guide*.
11. Follow steps 9 and 10 in the *Hard-Ceiling Mount* section to adjust the angle, focus and zoom of the camera.
12. Follow steps 11 and 12 in the *Hard-Ceiling Mount* section to secure the thread lock, replace the silica gel bag and secure the housing cover.



## 14.4 Connecting the Camera

Connect your Vandal Proof IP Dome to power, network and other cables.

### 14.4.1 Wire Definition

The cables for Vandal Proof IP Dome are illustrated and defined below.

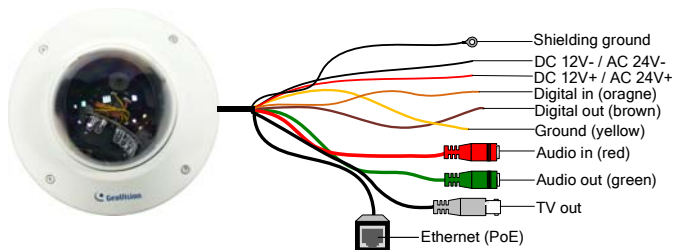

No.	Wire Color	Definition
1	Black (thick)	Shielding Ground
2	Black (thin)	DC 12V- / AC 24V-
3	Red	DC 12V+ / AC 24V+
4	Orange	Digital In
5	Brown	Digital out
6	Yellow	Ground
7	Red RCA	Audio in
8	Green RCA	Audio out
9	Black BNC	TV out

**Note:** To use the TV out function, connect the black BNC connector to a monitor and select your signal format (NTSC or PAL) at the **TV Out** field on the Web interface. For details, see *Video Settings, Administrator Mode Chapter, GV-IPCam Firmware Manual* on the Software DVD.

## 14.4.2 Connecting the Power Cable

There are two ways to supply power to the camera:

- Use a Power over Ethernet (PoE) adapter to connect the camera to the network, and the power will be provided at the same time.
- Plug the power adaptor to the terminal block as shown below.

1. Insert the thin black wire of the Vandal Proof IP Dome to the left pin (-) and the red wire to the right pin (+).

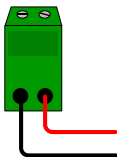

2. Connect the DC 12V Power Adaptor to the Terminal Block.



## 15. Vandal Proof IP Dome (Part II)

The information in this chapter applies to **GV-VD1530 / 1540 / 2430 / 2440 / 2530 / 2540 / 2540-E / 3430 / 3440 / 5340 / 5340-E**.

### 15.1 Packing List

- Vandal Proof IP Dome

- Torx Wrench



- 3-Pin Terminal Block



- Audio wires



- Power Adapter



- TV out wire



- Focus Adjustment Cap (for GV-VD1530 / 2430 / 2530 / 3430 only)



- RJ-45 Connector x 2



- Back Plate



- Installation sticker

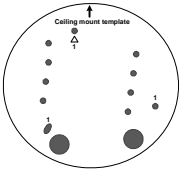

- Screw Anchor x 4



- Long Screw x 4



- Flat Screw



- Short Screw x 2



- Silica Gel Bag

- Sticker (for Silica Gel Bag)

- Ruler

- Conduit Converter

- Plastic PG21 conduit connector



- Power Adapter
- GV-Vandal Proof IP Dome Hardware Installation Guide
- Warranty Card
- GV-IPCAM Software DVD
- GV-NVR Software DVD

**Note:**

1. You can choose to run the wires through a conduit pipe. After you have threaded all the wires, install the supplied conduit converter and plastic PG21 conduit connector with a self-prepared 1/2" conduit pipe to the camera. Power will have to be supplied through a PoE adapter, because the power adapter wire does not fit in a 1/2" pipe. You will have to purchase your own PG21 conduit connector if you want to use 3/4" or 1" pipe.

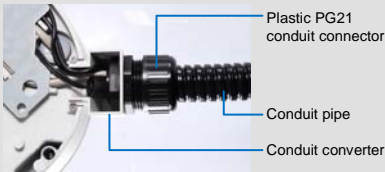

A metal PG21 conduit connector can be purchased upon request. The metal PG21 conduit connector can be connected with a 3/4" pipe.

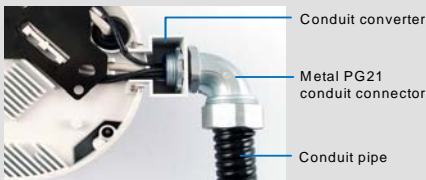

2. The power adapter can be excluded upon request.

## 15.2 Overview

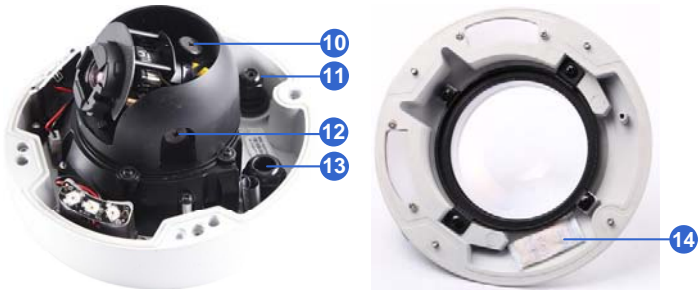

No.	Name	Description
1	LED Indicators	The power LED (top) turns on (green) when the power is on and turns off when there is no power supply. The status LED (bottom) turns on (green) when the system operates normally and turns off when system error occurs.
2	Audio In	Connects to a microphone for audio output.
3	LAN / PoE	Connects to a 10/100 Ethernet or PoE.
4	Default Button	Resets the camera to default settings. See <i>27. Restoring to Default Settings</i> in the <i>Quick Start Guide</i> .
5	Video Out	Connects to a portable monitor for setting the focus and angle of the camera during initial setup.
6	Memory Card Slot	Inserts a micro SD card (SD/SDHC, version 2.0 only, Class 10) to store recording data.
7	Audio Out	Connects to a speaker for audio output.
8	DC 12V / AC 24V	Connects to power.
9	I/O Terminal Block	Connects to an I/O device.
10	Rotational Screw	Loosens to rotate the camera.
11	Cable seal	Waterproofs the Ethernet cable.
12	Tilt Screw	Loosen the screw to tilt the camera.
13	Conduit Connector	Waterproofs the audio, TV out, power adapter and I/O wires.
14	Silica Gel Bag	Absorbs moisture in the camera body.
<p><b>Note:</b> To use the <b>Video Out</b>, connect the black BNC connector to a monitor and select your signal format (NTSC or PAL) at the <b>TV Out</b> field on the Web interface. For details, see <i>Video Settings, Administrator Mode</i> Chapter, <i>GV-IPCAM Firmware Manual</i> on the Software DVD.</p>		



## 15.3 Installation

The Vandal Proof IP Dome is designed for outdoors. With the standard package, you can install the camera on the ceiling.

**Note:** You can also install the camera:

- on a power box (of the 4" square and double gang type) using the standard package
- to ceilings, wall corners (concave or convex), and poles using optional mounting kits

For details on these installations, see *GV-Mount Accessories Installation Guide* on the Software DVD.

**IMPORTANT:** When installing the Vandal Proof IP Dome near the corner, maintain at least 25 cm away from the walls to avoid reflection problems.

1. Remove the housing cover with the supplied torx wrench.
2. Thread wires into the camera.
  - A. Unscrew the conduit connector from the back.

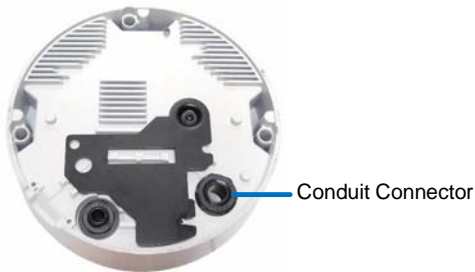

- B. Unplug the conduit connector inside the housing and disintegrate the connector. You should have 4 parts:

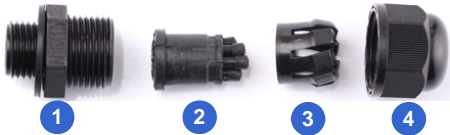

- C. Remove the terminal block from the power adapter.
- D. Thread the audio wires (optional), TV out wire (optional), adapter wires and I/O wires (optional) through the conduit entry and then through part 1, 2, 3 and 4 of the conduit connector.

**Tip:**

1. To make the threading easier, it is advised to thread the wires in the order described here.
2. Use a pair of pliers to help you pull the wires through the camera.

For part 2, there are 8 holes each labeled with its diameter. Remove the plugs and push the wires to the corresponding hole listed below:



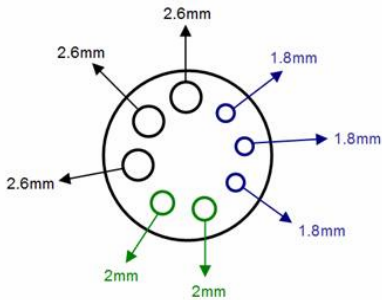

2.6 mm: Audio, BNC

2 mm: DC12V / AC24V

1.8 mm: DIDO

#### IMPORTANT:

1. Use the supplied ruler and leave about 10 cm of power and I/O wires between their connectors and the cable seal; leave at least 11 cm of audio/TV-out wires between their connectors and the cable seal.
2. The plugs are used to prevent water from entering the camera housing. Keep the unused holes plugged and save the removed plugs for future use.
3. Only thread the wires through their designated holes on the conduit connector to make sure the wires are properly sealed.

3. Install the Ethernet cable.
  - A. Rotate to remove the indicated cap and the plug inside.



- B. Thread an Ethernet cable (the end with no RJ-45 connector) from the back panel through the cable seal.



**IMPORTANT:** Use the supplied ruler and leave about 11 cm of the Ethernet cable between the connector and the cable seal.

- C. Re-install the cap. Make sure the cap is installed tightly to waterproof the camera.

4. Connect the wires to the camera.
  - A. Install the terminal blocks to the power adapter and I/O devices. See *15.4 Connecting the Camera* in the *Quick Start Guide*.
  - B. Install the supplied RJ-45 connector to the Ethernet cable.
  - C. Plug all the connectors to the camera panel.

**Tip:** Unscrew the indicated screws and lift the camera to help you connect the wires.



- D. Arrange the wires in the conduit connector and re-install it to the camera.

- Sort out the wires at the back. You can have the wires come out from position A, B or both. The instructions here describe sorting wires for position A.

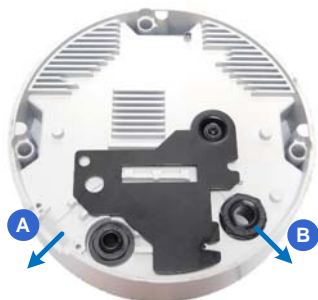

From the back of the camera housing, unscrew and rotate the plate to one side, sort out the wires and secure the plate back.



6. Secure the back plate to the ceiling.
- A. Paste the sticker to the ceiling. The arrow on the sticker indicates the direction that the camera faces.

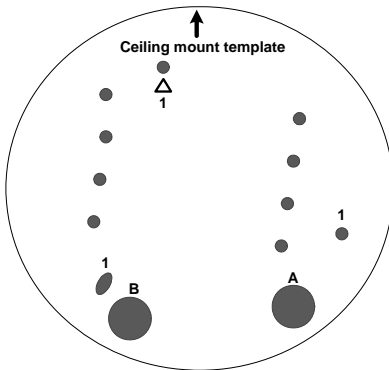

- B. Drill 3 holes for screws. The recommended ones are indicated as '1'.
- C. Insert the screw anchors to the 3 holes.
- D. Depending on how you want to run the wires (see step 5). Drill the right hole (on the installation sticker) for position A and the left for position B or both if required.
- E. Secure the back plate to the ceiling with long screws.

7. Secure the camera to the ceiling.
  - A. Secure the safety lock to the camera using a short screw. Use flat screw for number 1 and small screw for number 2.



- B. Thread all the wires into the ceiling and connect them.
    - C. Secure the camera using the torx wrench.



8. Access the live view. See [24.2 Accessing the Live View](#) in the *Quick Start Guide*.
9. Adjust the camera's angle, focus and zoom of the camera.



### Pan Adjustment



### Tilt Adjustment



### Rotational Adjustment



10. Replace the silica gel bag and secure the camera cover using the torx wrench.

**IMPORTANT:** If the center of the camera view is less than  $25^\circ$  to the ceiling, or lower than the grey line (as illustrated below), disassemble the indicated ring so the view is not obstructed. However, with the ring disassembled, slight reflections may occur.



## 15.4 Connecting the Camera

Connect your Vandal Proof IP Dome to power, network and other wires needed.

### 15.4.1 Connecting the Power Cable

There are two ways to supply power to the camera:

- Use a Power over Ethernet (PoE) adapter to connect the camera to the network, and the power will be provided at the same time.
- Plug the power adapter to the terminal block by inserting the striped wire to the right pin (-) and the black wire to the left pin (+).



## 15.4.2 Connecting the I/O Device

The camera support one digital input and one digital output of dry contact.

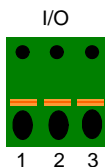

Pin	Function
1	Digital Output
2	GND
3	Digital Input

For details on how to enable an installed I/O device, see *I/O Settings*, *Administrator Mode* Chapter, *GV-IPCAM Firmware Manual* on the Software DVD.

# 16. Vandal Proof IP Dome (Part III)

The information in this chapter applies to **GV-VD3700/5700**.

## 16.1 Packing List

- H.265 Vandal Proof IP Dome

- Torx Wrench



- Long Screw x 4

- Screw Anchor x 4



- Back Plate

- Short Screw (for Back Plate)  
x 3



- Installation sticker

- RJ-45 Connector x 2

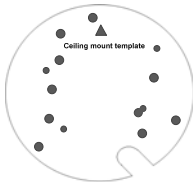

- Cable Stopper



- Anti-Drop Wire



- Screw (for the Anti-Drop Wire)



- Silica Gel Bag x 2

- Sticker (for Silica Gel Bag) x 2

- GV-IPCAM Software DVD

- GV-Software DVD

- Pan Angle Notification Card

- Warranty Card

**Note:** The supplied anti-drop wire is used for attaching the camera body to GV-Mount206. For more details, see *GV-Mount Accessories Installation Guide* on the Software DVD.

## 16.2 Overview

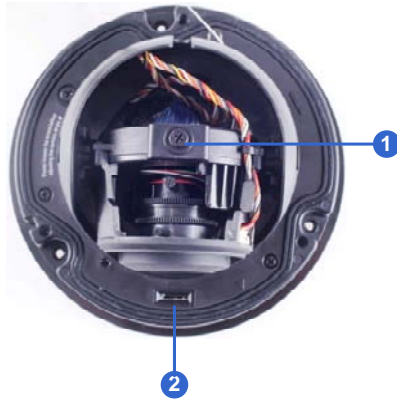

No.	Name	Description
1	Rotational Screw	Loosen to rotate the lens.
2	SD Card Slot	Insert a micro SD card (SD/SDHC/SDXC, Class 10) to store recording data. * UHS-II card type is not supported.
3	Base Screw	Loosen to pan the camera.
4	Tilt Screw	Loosen to tilt the camera.
5	Default Button	Reset the camera to default settings. See <i>27. Restoring to Default Settings</i> in the Quick Start Guide.



## 16.3 Installation

The Vandal Proof IP Dome is designed for outdoors. With the standard package, you can install the camera on the ceiling.

1. Remove the housing cover with the supplied torx wrench.



2. Thread the Ethernet cable into conduit connector. For details, see step 6, *10.3 Installation*.



**Note:** If you can't plug the self-prepared RJ-45 connector into the jack of the conduit, it is suggested to use the supplied RJ-45 connector.

3. Connect the audio wires (optional), power adapter wires and I/O devices (optional) to the camera. See *16.4 Connecting the Camera*.
4. Secure the back plate to the ceiling.
  - A. Paste the sticker to the ceiling. The triangle on the sticker indicates the direction that the camera faces.

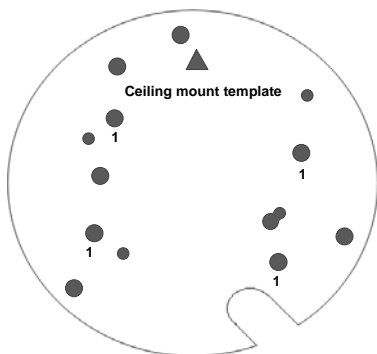

- B. Drill 4 holes for screws. The recommended ones are indicated as '1'.
- C. Insert the screw anchors to the 4 holes on the ceiling.
- D. Secure the back plate to the ceiling with 4 long screws.

- E. Align and secure the back plate to the rear side of the camera with the supplied short screws.



5. Insert your micro SD card into the SD card slot.



6. Access the live view. See *2.1 Accessing the Live View, GV-IPCAM Firmware Manual*.
7. Based on the live view, adjust the camera's angle, focus and zoom.

## Pan Adjustment



### IMPORTANT:

1. Loosen the Base Screw (No. 3, 16.2 Overview) before adjusting the camera pan angle.
2. The front of the camera is marked with a white line in front of the memory card slot. When adjusting the camera pan angle, avoid turning the camera for more than 180 degrees in either direction. Continuous rotation greater than 180 degrees could pull off the internal cable and cause the camera to malfunction.

## Tilt Adjustment



## Rotational Adjustment



8. Paste the silica gel bag with a sticker right behind the lens.



9. Secure the housing cover back to the camera body.

**Note:** You can remove the cable stopper to thread the camera's cable through the side opening.



## 16.4 Connecting the Camera

Connect your Vandal Proof IP Dome to power, network and other cables needed.

### 16.4.1 Definition



Pin	Wire Name	Definition	
1	4-Pin terminal block	DI +	Digital out +
2		DI -	Digital out -
3		DO +	Digital in +
4		DO -	Digital in -
5	5-Pin terminal block	L – Out	Audio out
6		A GND	Audio ground
7		L – IN	Audio in
8		GND	DC 12 V +
9		12 V	DC 12 V -
Wire	Definition		
RJ-45	Ethernet or PoE		

## 16.4.2 Power Connection

There are two ways to supply power to the camera:

- Use a Power over Ethernet (PoE) adapter to connect the camera to the network, and the power will be provided at the same time.
- Connect the wires of your power adapter to the DC 12V+ and DC 12V- pins of the terminal blocks.



# 17. Target Vandal Proof IP Dome

## 17.1 Packing List

- Target Vandal Proof IP Dome

- Screw x 4



- TV-Out Wire



- Installation sticker

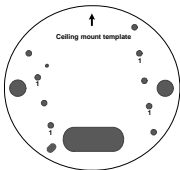

- Torx Wrench



- Screw Anchor x 4



- Audio Wires x 2



- RJ-45 Connector





- Conduit Converter



- Water proof rubber set  
(for RJ-45 and DC12V)



- Big Concave hexagon  
Wrench



- Small Concave hexagon  
Wrench



- Silica Gel Bag

- Sticker (for Silica Gel Bag)

- GV-IPCAM Software DVD

- Ruler

- GV-NVR Software DVD

- Warranty Card

**Note:** With the supplied Conduit Converter, you can choose to run the wires through a conduit pipe. The installation of conduit converter and conduit pipe is illustrated as below. You may optionally purchase a plastic or metal PG21 conduit connector for a 1/2" or 3/4" pipe respectively. When you use a 1/2" pipe, power will have to be supplied through a PoE adapter because the power adapter wire does not fit in a 1/2" pipe.

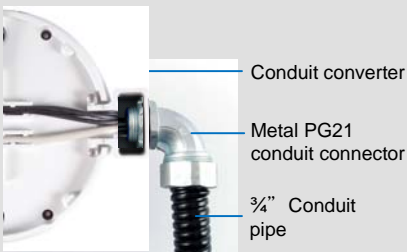
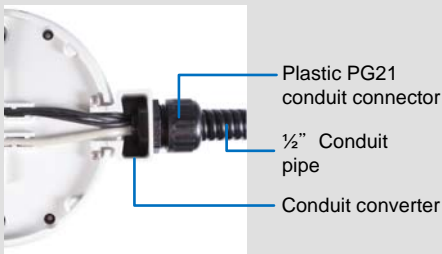

## 17.2 Overview

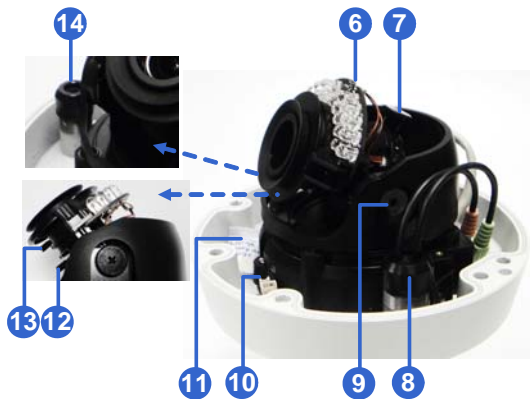
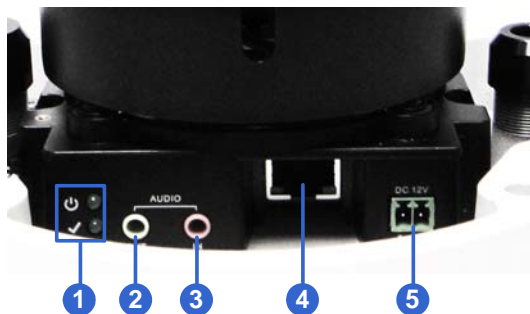

No.	Name	Description
1	LED Indicators	The power LED (top) turns on (green) when the power is on and turns off when there is no power supply. The status LED (bottom) turns on (green) when the system operates normally and turns off when system error occurs.
2	Audio Out	Connects to a speaker for audio output.
3	Audio In	Connects to a microphone for audio input.
4	LAN / PoE	Connects to a 10/100 Ethernet or PoE.
5	DC 12V	Connects to power.
6	Default Button	Resets the camera to default settings. See <i>27. Restoring to Default Settings</i> in the <i>Quick Start Guide</i> .
7	Rotational Screw	Loosens to rotate the camera.
8	Cable seal	Waterproofs the Ethernet cable.
9	Tilt Screw	Loosens the screw to tilt the camera.
10	TV-Out	Provides video input (D1 resolution) for a monitor.
11	Silica Gel Bag	Absorbs moisture in the camera body.
12	Zoom Screw	Adjusts the zoom of the camera.
13	Focus Screw	Adjusts the focus of the camera.
14	Conduit Connector	Waterproofs the audio wires.

**Note:** To use the TV out function, connect the supplied black BNC wire to a monitor and select your signal format (NTSC or PAL) at the **TV Out** field on the Web interface. The default signal format is NTSC. For details, see *4.1.1 Video Settings, GV-IPCam Firmware Manual*. The TV-out wire must be removed before you secure the housing cover.

## 17.3 Installation

The Target Vandal Proof IP Dome is designed for outdoors. With the standard package, you can install the camera on the ceiling.

1. Remove the housing cover with the supplied torx wrench.



2. Remove the back plate with the supplied torx wrench and remove the safety lock with a Philips screwdriver. Keep the removed screw for later use.



3. Thread an Ethernet cable and/or the adapter wire into the camera.
  - A. Rotate to remove the indicated cap.



- B. Take out and disintegrate the connector. You should have 3 parts:



- C. Thread an Ethernet cable (the end without RJ-45 connector) and/or the adapter wire from the back panel.



- D. If you are using PoE, thread an Ethernet cable through part 1 of the connector..

- E. If you are using DC 12V, change the connector to the supplied Waterproof rubber set. Remove the terminal block from the power adapter and thread the adapter wire through the rubber.

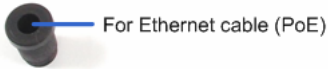
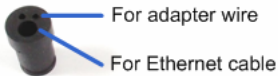

- F. Thread the Ethernet cable and/or the adapter wire through part 2 and 3 of the connector.



**IMPORTANT:** Use the supplied ruler and leave about 14 cm of the Ethernet cable and 10 cm of the adapter wire between the connector and the cable seal.

- G. Re-install the cap (part 3) with the supplied big concave hexagon wrench. Make sure the cap is installed tightly to waterproof the camera.

4. Thread audio wires (optional) into the camera.
  - A. Rotate to remove the cap of the conduit connector.



- B. Take out and disintegrate the connector. You should have 3 parts too.
    - C. Thread the audio wires from the back panel, remove the plugs of part 1 and thread through the 3 parts of the connector.



- D. Re-install the cap (part 3) with the supplied small concave hexagon wrench. Make sure the cap is installed tightly to waterproof the camera.



**Tip:** Use a pair of pliers to help you pull the wires through the camera.

**IMPORTANT:**

1. Use the supplied ruler and leave about 10 cm of the audio wires between the connectors and the cable seal.
  2. The plugs are used to prevent water from entering the camera housing. Keep the unused holes plugged and save the removed plugs for future use.
5. Connect the wires to the camera.
- A. Install the terminal block to the power adapter. See *17.4 Connection the camera.*
  - B. Install the supplied RJ-45 connector to the Ethernet cable.
  - C. Plug all the connectors to the camera panel.

**Tip:** Unscrew the indicated screws and lift the camera to help you connect the wires.



- Sort out the wires at the back. You can have the wires come out from both positions A and B, or from C.

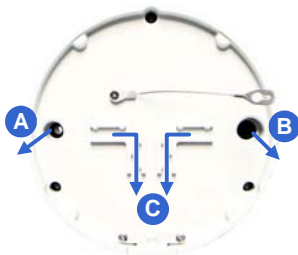

- Secure the back plate to the ceiling.
  - Paste the sticker to the ceiling. The arrow on the sticker indicates the direction that the camera faces.

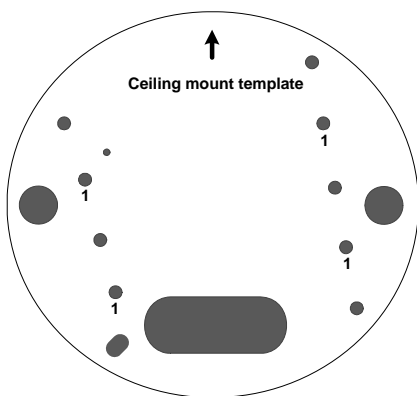

- Drill 4 holes for screws. The recommended ones are indicated as '1'.
- Insert the screw anchors to the 4 holes.

- D. Drill A & B holes or only C hole for sorting out the wires according to Figure 5-11.
  - E. Secure the back plate to the ceiling with the supplied screws.
8. Secure the camera to the ceiling.
- A. Secure the safety lock to the camera with the screw you removed from the back plate in step 2.



- B. Thread all the wires into the ceiling and connect them.
- C. Secure the camera with the torx wrench.



9. Access the live view. See 24.2 *Accessing the Live View* in the *Quick Start Guide*.

**Note:** The TV-out function can be used to access the live view. See the Note for TV-out in 17.2 *Overview*.

10. Adjust the camera's angle, focus and zoom of the camera.

#### Pan Adjustment



#### Tilt Adjustment



#### Rotational Adjustment



11. Replace the silica gel bag, press all the wires and cables into the notch and secure the camera cover with the torx wrench.



## 17.4 Connecting the Camera

There are two ways to supply power to the camera:

- Use a Power over Ethernet (PoE) adapter to connect the camera to the network, and the power will be provided at the same time.
- Plug the power adapter to the terminal block by inserting the striped wire to the right pin (-) and the black wire to the left pin (+).



# 18. Fixed IP Dome

## 18.1 Packing List

### 18.1.1 Packing List for Hard-Ceiling Mount

- Fixed IP Dome

- Torx Wrench



- Mounting Plate



- Short Screw Anchor x 3



- Ceiling Screw x 3



- Plate Screw x 3



- TV-out Wire



- Sticker

- GV-IPCam Software DVD

- Power Adapter

- GV-NVR Software DVD

- Warranty Card

**Note:** The power adapter can be excluded upon request.

## 18.1.2 Packing List for In-Ceiling Mount

- In-Ceiling Housing Cover



- Mounting Plate



- Mounting Bracket x 3



- Copper Pillar x 3



- Copper Pillar Screw x 6



- Bracket Screw x 3



- Thread Lock Screw



- Housing Cover Thread

- Sticker (In-Ceiling Mount)

- Warranty Card



## 18.2 Overview

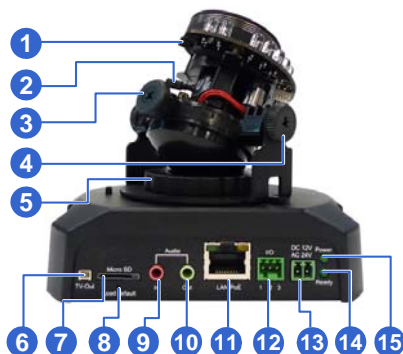

No.	Name	Description
1	Focus Screw	Adjusts the focus of the camera.
2	Zoom Screw	Adjusts the zoom of the camera.
3	Rotational Screw	Loosens to adjust the camera angle.
4	Tilt Screw	Loosens the screw to tilt the camera.
5	Pan Disc	Loosens to pan the camera.
6	Video Out	Connects to a portable monitor for setting the focus and angle of Fixed IP Dome during initial installation.
7	Memory Card Slot	Receives a micro SD card (SD/SDHC, version 2.0 only, Class 10) to store recording data.
8	Default Button	Resets the camera to default settings. See <i>27. Restoring to Default Settings</i> in the <i>Quick Start Guide</i> .
9	Audio In	Connects a microphone for audio input.

No.	Name	Description
10	Audio Out	Connects a speaker for audio output.
11	LAN / PoE	Connects to a 10/100 Ethernet or PoE.
12	I/O Terminal Block	Connects to I/O devices. For details, see <i>Fixed IP Dome</i> Chapter in the <i>GV-IPCAM Firmware Manual</i> on the Software DVD.
13	DC 12V Port	Connects to power.
14	Status LED	Turns on (green) when the system operates normally and turns off when system error occurs.
15	Power LED	Turns on (green) when the power is on and turns off when there is no power supply.

## 18.3 Installation

The Fixed IP Camera is designed for indoors. With the standard packing, there are three ways to install the Fixed IP Camera: **hard-ceiling mount**, **in-ceiling mount** and **wall-surface mount**.

### 18.3.1 Hard-Ceiling Mount



1. Paste the supplied sticker onto a desired location on the ceiling. Drill the three red dots and the ellipse mark only if you wish to run the wires into the ceiling.
2. Unpack the camera package and take out the camera body.

Use the torx wrench to loosen the housing cover at the front and the back



Take out the camera body



3. Secure the camera body and the mounting plate to the ceiling with the three ceiling screws.

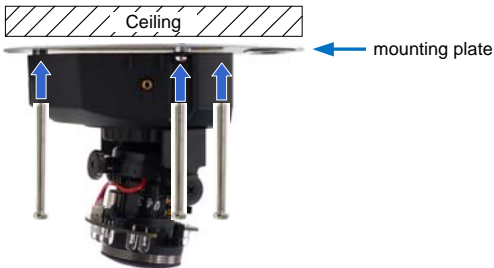

4. Connect the network and power cables to the camera. See 18.4 *Connecting the Camera* in the *Quick Start Guide*.
5. Access the live view. See 24.2 *Accessing the Live View* in the *Quick Start Guide*.
6. Adjust the camera to a desired angle as illustrated below.

**Tip:** The 3-axis mechanism offers flexible and easy ceiling / wall installation.

### Pan Adjustment



### Tilt Adjustment



### Rotational Adjustment



7. Adjust for image clarity using the GV-IP Device Utility program. For details, see 24.3 *Adjusting Image Clarity* in the *Quick Start Guide*.



8. Secure the housing cover as shown in step 2. Remove the indicated part when necessary.



**Note:** Adjust the black mask inside the housing cover to make sure the camera view is not obscured.

### 18.3.2 In-Ceiling Mount



1. Follow step 2 in the *Hard-Ceiling Mount* section to remove the housing cover and take out the camera body.
2. Paste the supplied sticker onto a desired location on the ceiling and cut a circle on the ceiling along the edge of the sticker.
3. On the mounting plate, locate the 3 holes labeled as 1 and insert the 3 copper pillars from the back side.



4. From the side with the numbering, secure the copper pillars with 3 copper pillar screws.

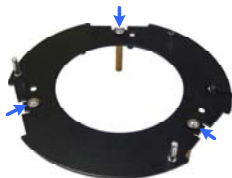

5. Place the 3 mounting brackets at the indent next to the copper pillars (labeled as 2 on the mounting plate) and secure them using the 3 bracket screws.



6. Place the mounting plate on the camera body with the copper pillars inserted in the locations indicated below. The arrow on the mounting plate should be pointing toward the front of the camera.



7. From the bottom of the camera, secure the copper pillars using the 3 copper pillar screws.
8. Place the camera into the ceiling opening.



9. On the back side, make sure the black plastic clips are slightly above the ceiling board and pointing outward.



Back Side



Front Side

10. Tighten the bracket screws from the front side of the camera.
11. Connect the network and power cables to the camera. See *18.4 Connecting the Camera* in the *Quick Start Guide*.
12. Access the live view. See *24.2 Accessing the Live View* in the *Quick Start Guide*.
13. Follow steps 6 and 7 in the *Hard-Ceiling Mount* section to adjust the angle, focus and zoom of the camera.
14. Use the housing cover thread and the thread lock screw to attach the housing cover to the camera body.



15. Place the housing cover on the camera body with the GeoVision logo pointing toward the front of the camera.



### 18.3.3 Wall-Surface Mount



1. Follow step 2 in the *Hard-Ceiling Mount* section to remove the housing cover and take out the camera body.
2. Paste the supplied sticker onto a desired location on the wall. Drill the three red dots, and the ellipse mark only if you wish to run the wires into the wall.
3. Insert the short screw anchors and secure the camera and the mounting plate with three plate screws.

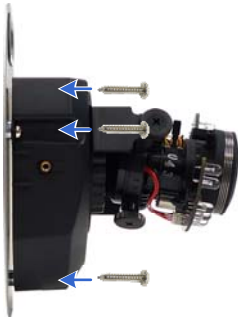

4. Connect the network and power cables to the camera. See 18.4 *Connecting the Camera* in the *Quick Start Guide*.
5. Access the live view. See 24.2 *Accessing the Live View* in the *Quick Start Guide*.

6. Follow steps 6 and 7 in the *Hard-Ceiling Mount* section to adjust the angle, focus and zoom of the camera.
7. Follow step 8 in the *Hard-Ceiling Mount* section to secure the housing cover.

## 18.4 Connecting the Camera



1. Use a standard network cable to connect the camera to your network.
2. Optionally connect a speaker and an external microphone.
3. Optionally connect a monitor using a Video Out wire. Enable the function by selecting the signal format in the **TV Out** field in the Web interface. See *TV Out setting*, in the *Video Settings* section, *Administrator Mode* Chapter, *GV-IPCAM Firmware Manual* on the Software DVD.
4. Optionally connect to input / output devices. For details, see *I/O Terminal Block, Fixed IP Dome* Chapter, *GV-IPCAM Firmware Manual* on the Software DVD.
5. Connect power using one of the following methods:
  - plugging the power adapter to the power port.
  - using the Power over Ethernet (PoE) function and the power will be provided over the network cable.
6. The status LED of the camera will be on.

## 19. Target Fixed IP Dome

### 19.1 Packing List

- Target Fixed IP Dome

- Screw x 3



- TV-Out Wire



- GV-IPCam Software DVD

- GV-NVR Software DVD

- Torx Wrench



- Screw Anchor x 3



- Installation sticker



- Warranty Card

**Note:** The power adapter can be purchased upon request.

## 19.2 Overview



No.	Name	Description
1	Lens	Receives image inputs.
2	Focus Screw	Adjusts the focus of the camera.
3	Zoom Screw	Adjusts the zoom of the camera.
4	Default Button	Resets the camera to default settings. See 27. <i>Restoring to Default Settings.</i>
5	TV-Out	Provides video inputs (D1 resolution).
6	Rotational Screw	Loosens to adjust the camera angle.
7	Pan Disc	Loosens to pan the camera.
8	Power	Turns on (green) when power is on.
9	Status	Turns on (green) when the system is ready.
10	Audio Out	Connects a speaker for audio output.
11	Audio In	Connects a microphone for audio input.
12	Link	Turns on (green) when the network is connected.

No.	Name	Description
13	ACT	Turns on (orange) when data are being transmitted.
14	DC 12V Port	Connects to power.
15	LAN / PoE	Connects to a 10/100 Ethernet or PoE.
16	Tilt Screw	Loosens the screw to adjust tilt angle.

**Note:** The TV-out function can only be used during installation to adjust the focus of the camera. To use the TV out function, connect the supplied black BNC wire to a monitor and select your signal format (NTSC or PAL) at the **TV Out** field on the Web interface. The default signal format is NTSC. For details, see *4.1.1 Video Settings, GV-IPCam Firmware Manual*. The TV-out wire must be removed before you secure the housing cover.



## 19.3 Installation

The Target Fixed Dome can be installed on the wall or the ceiling. Before installing the camera, make sure the installing site is shielded from rain and moisture.

1. Use the supplied torx wrench to loosen three screws on the housing cover, and take out the camera body.



2. Place the installation sticker where you want to install it, and make 3 marks on the ceiling or the wall for screw anchors.



3. Drill the marks and insert the screw anchors.
4. Connect the camera to network and power. For details, see [19.4 Connecting the Camera](#).
5. Secure the camera to the ceiling or the wall with the supplied screws.
6. Access the live view. For details, see [24.2 Accessing the Live View](#) in the *Quick Start Guide*.

**Note:** The TV-out function can be used to access the live view. For details, see the Note for TV-out in *19.2 Overview*.

- Adjust image clarity using the GV-IP Device Utility program. For details, see *24.3 Adjusting Image Clarity* in the *Quick Start Guide*.
- Loosen the tilt screw, pan screw or rotational screw. Adjust the angles based on the live view as needed, and tighten the screws again.

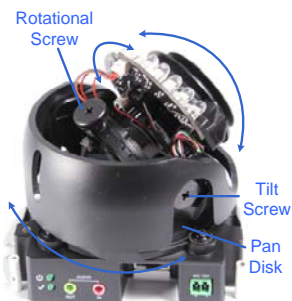

- Place the housing cover back and tighten the three screws to secure it. Remove the indicated part when necessary.



## 19.4 Connecting the Camera



1. Connect power using one of the following methods:
  - Plug the power adapter to the 12V terminal block. The power adapter is an optional device. For detail, see *Options* in the manual.
  - Use the Power over Ethernet (PoE) function and the power will be provided over the network cable.

The power and status LEDs shall turn on (green).

2. Use a standard network cable to connect the camera to your network.
3. You are ready to access the live view, adjust the image clarity and configure the basics. See *Getting Started, Chapter 2, GV-IPCam Firmware Manual*.

## 20. Cube Camera

### 20.1 Packing List

- Cube Camera

- Supporting Rack



- Screw x 3



- Screw Anchor x 3



- GV-IPCam Software DVD

- Power Adapter

- GV-NVR Software DVD

- Warranty Card

**Note:** The power adapter can be excluded upon request.

## 20.2 Overview

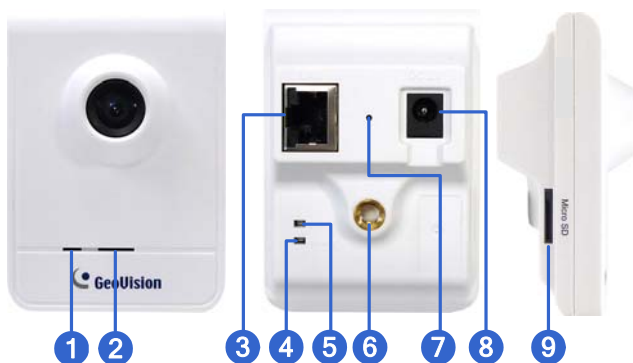

No.	Name	Description
1	Microphone	Receives sounds.
2	Speaker	Plays sounds.
3	LAN	Connects to a 10/100 Ethernet.
4	Status LED	Turns red when the system powers on. Turns orange when the system is ready.
5	LAN LED	Turns green when the camera is connected to the Internet.
6	Stand screw	Connects to the Supporting Rack.
7	Default Button	Resets the camera to default settings. See <i>27. Restoring to Default Settings</i> in the <i>Quick Start Guide</i> .
8	Power Port	Connects to the power adapter.
9	Memory Card Slot	Receives a micro SD card (SD/SDHC, version 2.0 only, Class 10) to store recording data.

## 20.3 Installation

Follow the steps below to install, connect to and adjust your Cube Camera.

1. Put the supporting rack on the desired location and make marks for screw anchors.



2. Drill the marks and insert the screw anchors.
3. Secure the supporting rack onto the wall using the supplied screws.
4. Screw the camera onto the supporting rack and fasten the indicated screw.



5. Connect the network and power cables to the camera. See *20.4 Connecting the Camera* in the *Quick Start Guide*.
6. Access the live view. See *24.2 Assigning the Live View* in the *Quick Start Guide*.

7. Adjust the angles of the camera based on live view and fasten the indicated screw.



## 20.4 Connecting the Camera



1. Use a standard network cable to connect the camera to your network.
2. Power on using the power adapter.
3. The status LED of the camera will be orange. Then you can set the IP address for the unit. See *24. Accessing the Camera* in the *Quick Start Guide*.

**IMPORTANT:** Be sure to use the GeoVision power adapter to power up the camera. To use your own power cable, make sure you look up the power source value indicated at the camera's back panel.



## 21. Advanced Cube Camera

### 21.1 Packing List

- Cube Camera

- Supporting Rack



- Screw x 3



- Screw Anchor x 3



- GV-IPCam Software DVD

- Power Adapter

- GV-NVR Software DVD

- Warranty Card

**Note:** The power adapter can be excluded upon request.









## 21.2 Overview



No.	Name	Description
1	Speaker	Plays sounds for tampering and motion alarm, and listens to the audio around the camera. To set up alarm sound, see <i>Speaker</i> section, <i>Administrator Mode</i> Chapter, <i>GV-IPCAM Firmware Manual</i> on the Software DVD.
2	PIR sensor	Passive infrared sensor.
3	Microphone	Receives sounds.
4	White Illumination LED	When the PIR sensor detects the movement, the white illumination LED lights up in a low light scene. To set up the LED, see <i>Video Settings</i> section, <i>Administrator Mode</i> Chapter, <i>GV-IPCAM Firmware Manual</i> on the Software DVD.
5	Monitoring LED	Reflects monitoring status of the camera. See the below table.
6	Live View LED	Reflects live view status of the camera. See the below table.
7	LAN / PoE	Connects to a 10/100 Ethernet or PoE.

No.	Name	Description
8	Stand screw	Connects to the Supporting Rack.
9	Power port	Connects to the power adapter.
10	Ready LED	Reflects system status of the camera. See the below table.
11	LAN LED	Reflects LAN status of the camera. See the below table.
12	Memory Card Slot	Receives a micro SD card (SD/SDHC, version 2.0 only, Class 10) to store recording data.

**IMPORTANT:** The White Illumination LED can reach high temperatures. Be sure not to touch the LED with bare hand.

LED	Status	Description
Live View 		<ul style="list-style-type: none"> <li>Turns on orange light when you see the live view.</li> </ul>
Monitoring 		<ul style="list-style-type: none"> <li>Turns on red light when you start monitoring.</li> </ul>
Ready 		<ul style="list-style-type: none"> <li>Turns on green light when the system is ready.</li> <li>Flashes green light when you load default value.</li> </ul>
LAN 	 	<ul style="list-style-type: none"> <li>Turns on green light when you connect the LAN Network.</li> <li>Turns on blue light when you connect the Wi-Fi Network (for GV-CAW120 / 220 only).</li> </ul>

## 21.3 Installation

Follow the steps below to install, connect to and adjust your Advanced Cube Camera.

1. Put the supporting rack on the desired location and make marks for screw anchors.



2. Drill the marks and insert the screw anchors.
3. Secure the supporting rack onto the wall using the supplied screws.
4. Screw the camera onto the supporting rack and fasten the indicated screw.



5. Connect the network and power cables to the camera. See 21.4 *Connecting the Camera* in the *Quick Start Guide*.
6. Access the live view. See 24.2 *Accessing the Live View* in the *Quick Start Guide*.

7. Adjust the angle of the camera based on live view and fasten the indicated screw.



8. For GV-CAW120/220, to connect to the Internet through wireless service, follow the steps in [24.2.3 Configuring the Wireless Connection](#) in the *Quick Start Guide*.

## 21.4 Connecting the Camera



1. Use a standard network cable to connect the camera to your network.
2. Connect power using one of the following methods:
  - Plug the power adapter to the power port.
  - Use the Power over Ethernet (PoE) function and the power will be provided over the network cable.
3. When the ready LED of the camera shines green, the camera is ready for use.

**Note:** PoE function is only supported for GV-CA120 and GV-CA220.

## 22. PT Camera

### 22.1 Packing List

- GV-PT130D/220D/320D

- Mounting Base



- Mounting Cover



- Wall Mount Bracket



- Screw Anchor x 3



- Long Screw x 3



- Short Screw x 3



- Round Screw x 3



- Terminal Block
- Power Adapter
- GV-NVR Software DVD
- Washer x 3
- Three small, circular, metallic washers arranged horizontally.
- GV-IPCAM Software DVD
- Warranty Card

**Note:** The power adapter can be excluded upon request.



## 22.2 Overview



No.	Name	Description
1	DC 12V / AC 24V Terminal Block	Connects to a DV 12V or AC 24V Power Adapter.
2	LAN / PoE	Connects to a 10/100 Ethernet or PoE.
3	I/O Terminal Block	Connects to I/O terminal device. For details, see <i>I/O Terminal Block</i> , <i>PTZ Camera</i> Chapter, <i>GV-IPCAM Firmware Manual</i> on the Software DVD.
4	Memory Card Slot	Receives a micro SD card (SD/SDHC, version 2.0 only, Class 10) to store recording data.
5	Audio Out	Connects a speaker for audio output.
6	Audio In	Connects a microphone for audio input.
7	Status LED	Turns green when the system operates normally and turns off when system error occurs.
8	Power LED	Turns green when the power is on and turns off when the power is off.
9	Focus Ring	Manually rotates this ring left or right to adjust focus.
10	IR	Turns on to automatically illuminate a surveillance area by infrared light to produce clearer images during the night.
11	Microphone	Records the sounds.
12	Default	Resets the camera to default settings. See <i>24. Restoring to Default Settings</i> in the <i>Quick Start Guide</i> .

## 22.3 Installation

The GV-PT series is designed for indoor usage. Make sure that the installing location is shielded from rain and moisture. There are two ways to install the camera: **Ceiling Mount** and **L-Shaped Wall Mount**.

### 22.3.1 Ceiling Mount

1. Use the mounting base to make 3 marks on the wall for screw anchors.



2. Drill the marks and insert 3 screw anchors.
3. Attach the mounting base with the PT Camera with 3 short screws.

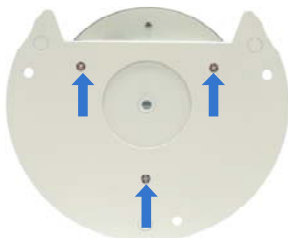

4. Fix the mounting base (now with the PT Camera attached) to the wall with 3 long screws.



5. Put on the mounting cover. To fit the installation environment, you can cut the parts indicated by arrows to make an opening for wires and cables.



### 22.3.2 L-Shaped Wall Mount

You may wall-mount the GV-PT series with or without the mounting cover.

1. Take the wall mount bracket and make 2 marks on the wall for screw anchors.

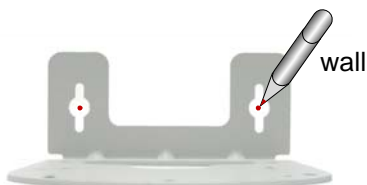

2. Drill the marks and insert 2 screw anchors.
3. Insert the long screws and leave enough distance (approximately 2 mm) to hang the wall mount bracket later.

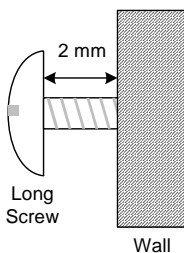

4. Hang the wall mount bracket on the screws and push the wall mount bracket downward. Make sure the long screws are tightened.

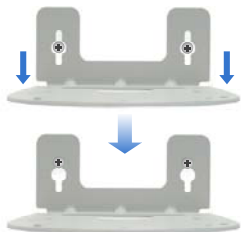

5. **Without Mounting Cover**

- Attach the wall mount bracket with the PT Camera using 3 washers and 3 round screws.



### With Mounting Cover

- To install the mounting cover, attach the mounting base to the camera and then put on the mounting cover. See steps 3 and 5 in *19.3.1 Ceiling Mount*.
- Attach the wall mount bracket with the PT Camera using 3 round screws.



## 22.4 Connecting the Camera

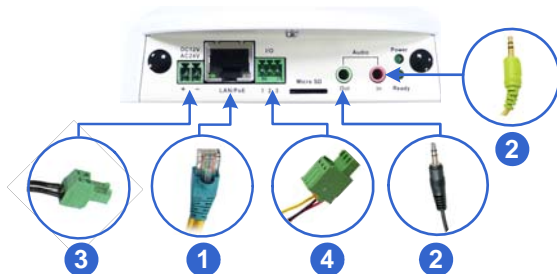

1. Use a standard network cable to connect the camera to your network.
2. Optionally connect a speaker and an external microphone.
3. Connect power using one of the following methods:
  - plugging the power adapter to the power port.
  - using the Power over Ethernet (PoE) function to provide power over the network cable.
4. Optionally connect to an input / output device. For details, see *I/O Terminal Block*, *PTZ Camera Chapter*, *GV-IPCAM Firmware Manual* on the Software DVD.
5. The status LED of the camera will be on.
6. Access the camera See 24. *Accessing the Camera* in the *Quick Start Guide*.
7. Adjust for image clarity using GV-IP Device Utility. For details, see 24.3 *Adjusting Image Clarity* in the *Quick Start Guide*.



## 23. Pinhole Camera

### 23.1 Packing List

- Pinhole Camera



- 1 m (3.28 ft) RJ-12 Cable



- Camera Adhesive Tape x 2



- Installation Sticker

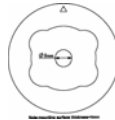

- Main Body Mount



- Main Body Adhesive Tape



- M3 Screw x 2



- M2 Screw



- GV-IPCAM Software DVD

- GV-NVR Software DVD

- Warranty Card

## 23.2 Overview

### Camera Lens



### Main Body

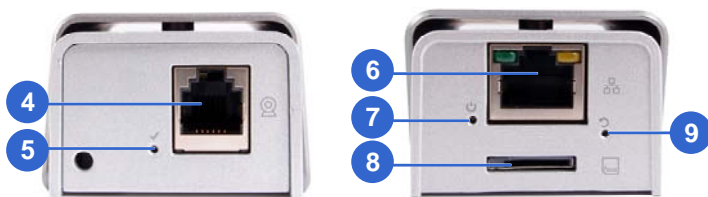

No.	Name	Description
1	Lens	Receives images.
2	Microphone	Receives sounds.
3	Lens Screw	Loosens to adjust the camera lens.
4	RJ12 Port	Use the supplied RJ12 cable to connect the camera lens and main body.
5	RJ12 Status LED	Turns on (green) when the camera lens and main body are connected.
6	PoE	Connects to a PoE adapter.
7	Status LED	Turns on (green) when the system is ready.
8	Memory Card Slot	Inserts a micro SD card (SD/SDHC, version 2.0, Class 10) to store recording data.
9	Default Button	Resets the camera to default settings. See <i>24. Restoring to Default Settings</i> in the <i>Quick Start Guide</i> .

## 23.3 Installation

The Pinhole Camera is designed for indoors. You can install the camera lens behind a wall or the ceiling board. Note that the thickness of the wall or ceiling board must be less than 4 mm.



1. Paste the installation sticker on the ceiling or the wall where you want to install the camera lens.
2. Drill a hole 9 mm in diameter. Be sure to remove the sticker after you finish drilling.

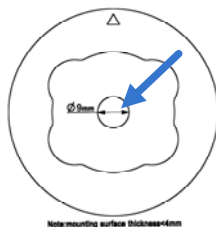

3. Paste one of the supplied camera adhesive tapes onto the camera lens.



4. Remove the backing paper on the other side of the adhesive tape and attach the camera lens onto the wall or ceiling. The arrows on the camera lens point toward the top of the camera view.



- Loosen the lens screw and adjust the position of the lens so that the metal ring is pressing against the wall or ceiling.

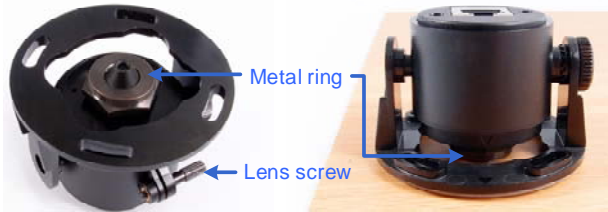

- Place the main body mount where you want to install it, and secure the mount using one of the methods below.
  - Insert and tighten the two supplied M3 screws.

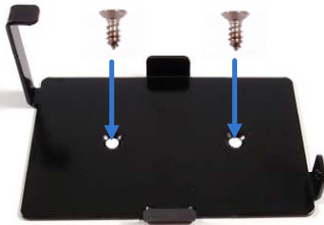

- Paste the main body adhesive tape on the bottom side of the main body mount.



7. Align the main body with the mount as shown below and secure with the supplied M2 screw.



8. Connect the camera lens and the main body using the RJ-12 cable.
9. Connect the main body to the network and supply power via the PoE cable. See 23.4 *Connecting the Camera* in the *Quick Start Guide*.
10. Access the live view. See 24.2 *Accessing the Live View* in the *Quick Start Guide*.



## 23.4 Connecting the Camera

1. Use the supplied RJ12 cable to connect the camera lens and the main body.



2. Use a Power over Ethernet (PoE) adapter to connect the camera to the network, and the power will be provided over the network cable.

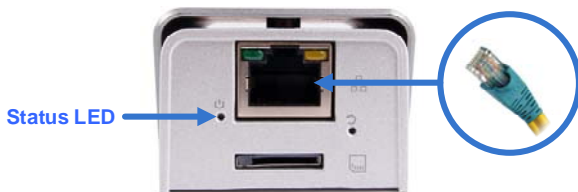

The status LED of the camera will be on.

## 24. Accessing the Camera

### 24.1 System Requirement

To access the GV-IP Camera through the Web browser, ensure your PC connects to the network properly and meets this system requirement:

- Microsoft Internet Explorer 7.x or later

**Note:**

1. For the users of **Internet Explorer 8**, additional settings are required. For details, see *Appendix A* in *GV-IPCAM Firmware Manual* on the Software DVD.
2. For GV-BX2600, **Microsoft Internet Explorer 11** or later is required.

## 24.2 Accessing the Live View

When the camera is connected to a network with a DHCP server, it will be automatically assigned with a dynamic IP address. See *24.2.1 Checking the Dynamic IP Address* to look up this IP address.

However, if you do not have a DHCP server on your network, access the camera by its default IP address **192.168.0.10** and see *2.1.2 Configuring the IP Address* for more detail.

**Note:**

1. The default ID and Password of the GV-IP Camera is **admin**.
2. By default, GV-PTZ010D is assigned with the fixed IP address 192.168.0.10.

## 24.2.1 Checking the Dynamic IP Address

Follow the steps below to look up the IP address and access the Web interface.

1. Install the GV-IP Device Utility program included on the *GV-IPCAM software DVD*.

**Note:** The PC installed with GV-IP Device Utility must be under the same LAN with the GV-IPCAM you wish to configure.

2. On the GV-IP Utility window, click the  button to search for the IP devices connected in the same LAN. Click the **Name** or **Mac Address** column to sort.

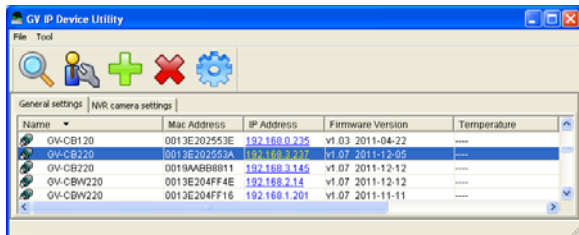

- Find the camera with its Mac Address, click on its IP address and select **Web Page**.

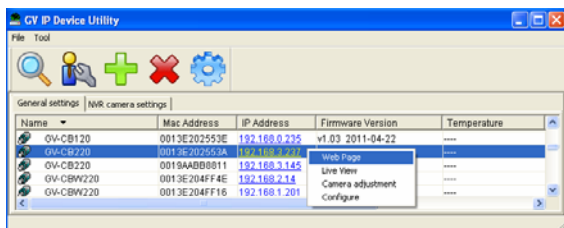

- The login page appears.

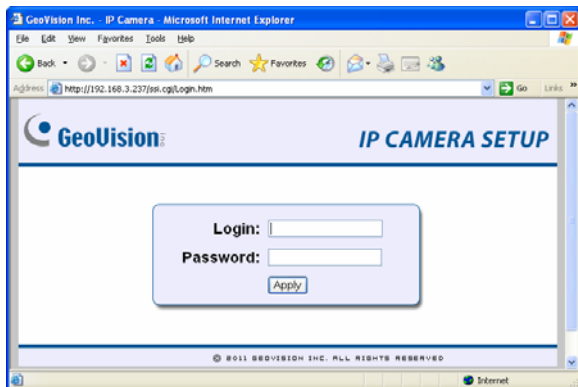

- Type the default ID and password **admin** and click **Apply** to log in.

## 24.2.2 Configuring the IP Address

Follow the steps below to configure the IP address.

1. Open your Web browser, and type the default IP address **http://192.168.0.10**.
2. In both Login and Password fields, type the default value **admin**. Click **Apply**.
3. In the left menu, select **Network** and then **LAN** to begin the network settings.

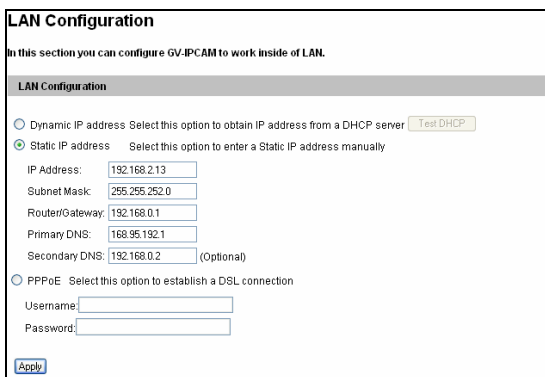

**LAN Configuration**

In this section you can configure GV-IPCAM to work inside of LAN.

**LAN Configuration**

Dynamic IP address Select this option to obtain IP address from a DHCP server

Static IP address Select this option to enter a Static IP address manually

IP Address:

Subnet Mask:

Router/Gateway:

Primary DNS:

Secondary DNS:  (Optional)

PPPoE Select this option to establish a DSL connection

Username:

Password:

4. Select **Static IP address**, **Dynamic IP address** or **PPPoE** and type the required network information.
5. Click **Apply**. The camera is now accessible by entering the assigned IP address on the Web browser.
6. To enable the updating of images in Microsoft Internet Explorer, you must set your browser to allow ActiveX Controls and perform a one-time installation of GeoVision's ActiveX component onto your computer.

**IMPORTANT:**

1. If **Dynamic IP Address** or **PPPoE** is enabled, you need to know which IP address the camera will get from DHCP server or ISP to log in. If your camera is installed in the LAN, use the GV-IP Device Utility to look up its current dynamic IP address. See *24.2.1 Checking the Dynamic IP Address* in the *Quick Start Guide*. If your camera uses a public dynamic IP address via PPPoE, use the dynamic DNS Service to obtain a domain name that is linked to the camera's changing IP address first. For details, see *LAN Configuration* and *Advanced TCP/IP* sections, *Administrator Mode Chapter* in the *GV-IPCAM Firmware Manual* on the Software DVD.
2. If **Dynamic IP Address** or **PPPoE** is enabled and you cannot access the camera, you may have to reset the camera to its factory default and then perform the network settings again. To restore factory settings, see *24. Restoring to Default Settings* in the *Quick Start Guide*.

## 24.2.3 Configuring the Wireless Connection

You may create wireless connection to the Internet for GV-BX1200 series / 1500 series / 2400 series / 3400 series / 5300, GV-MFD1501 Series / 2401 series / 3401 series / 5301 series, and GV-CAW120/220.

1. To set up the wireless LAN for the first time, power on and connect a standard network cable to the camera.
2. An IP address will be automatically assigned to the camera. Use GV IP Device Utility to search for the device. For details, see 24.2.1 *Checking the Dynamic IP Address* in the *Quick Start Guide*.
3. Configure the wireless settings.
  - A. On the Web interface, select **Network**, select **Wireless** and **Client Mode**. This dialog box appears.

### WLAN Configuration (Client Mode)

In this section you can configure your GV-IPCAM to act as Wireless Client.

**Wireless Client Setting**

Network name (SSID)

Network type  Ad Hoc  Infrastructure

Authentication Type  ▼

WPA-PSK Pre-shared Key

WEP

Key 1

Key 2

Key 3

Key 4

\* HEX: 10 or 26 hex digits. ASCII: 5 or 13 characters.

- B. Type the Network Name (SSID) or click the **Access Point Survey** button to search and select for the available Access Points/wireless stations.
- C. Select **Ad-Hoc** or **Infrastructure** for the Network type.



- D. Select the **Authentication Type** using the drop-down list. You can also obtain this information by clicking the **Access Point Survey** button.
- E. Type the **WPA-PSK Pre-shared Key** or **WEP** depending on the encryption setting for the Access Point.
- F. Click **Apply** to save the configuration.

**Note:**

1. Your encryption settings must match those used by the Access Points or wireless stations with which you want to associate.
2. When **Ad Hoc** is used, only **WEP** encryption is supported.
3. When you lose the wireless access, you can still access the unit by connecting it to a LAN and using the GV IP Device Utility to search for the device.

4. Enable wireless LAN.

- A. On the Web interface, select **Network** and **LAN**. This page appears.

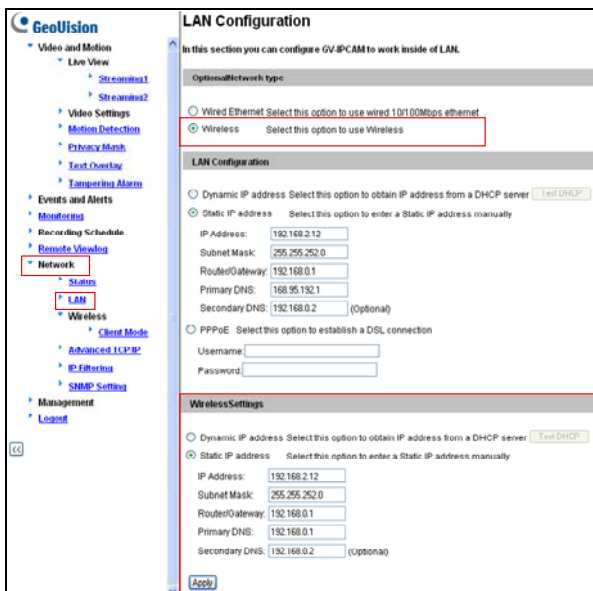

**GeoVision**

**LAN Configuration**

In this section you can configure GV-IPCAM to work inside of LAN.

**Optional Network type**

Wired Ethernet Select this option to use wired 1.0/1.00Mbps ethernet

Wireless Select this option to use Wireless

**LAN Configuration**

Dynamic IP address Select this option to obtain IP address from a DHCP server Test DHCP

Static IP address Select this option to enter a Static IP address manually

IP Address:

Subnet Mask:

Router/Gateway:

Primary DNS:

Secondary DNS:  (Optional)

PPPoE Select this option to establish a DSL connection

Username:

Password:

**Wireless Settings**

Dynamic IP address Select this option to obtain IP address from a DHCP server Test DHCP

Static IP address Select this option to enter a Static IP address manually

IP Address:

Subnet Mask:

Router/Gateway:

Primary DNS:

Secondary DNS:  (Optional)

- B. Select **Wireless** for Optional Network Type.
- C. To use a dynamic IP address assigned by the DHCP server, select **Dynamic IP address**. To use a fixed IP address, select **Static IP address** and type the IP address information.

5. Click **Apply**. The camera will start creating a wireless connection to the access point.

**Note:** For GV-CAW120/220, the LAN LED turns blue when the connection is established.

6. Unplug the Ethernet cable.

## 24.3 Adjusting Image Clarity

You can adjust the image clarity using the GV-IP Device Utility. Make sure that you have connected your GV-IPCAM to the network and install the GV-IP Device Utility program under the same LAN.

**Note:** This feature only applies to the cameras that allow manual focus adjustment.

1. Make sure you have installed the GV-IP Device Utility program included on the *GV-IPCAM software DVD*.
2. On the GV-IP Utility window, click the  button to search for the IP devices connected in the same LAN. Click the IP Address of the camera you desire. A drop-down list appears.

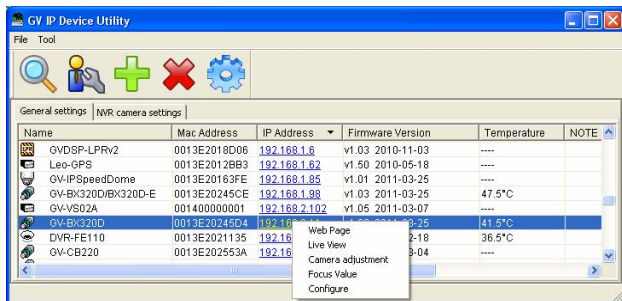

3. Select **Focus Value**. The Login dialog box appears.

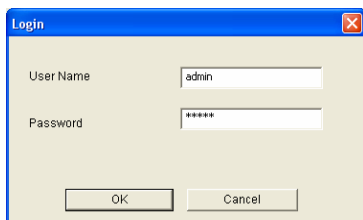

4. Type the user name and password of the camera selected. The default is **admin** for both user name and password. This window appears.

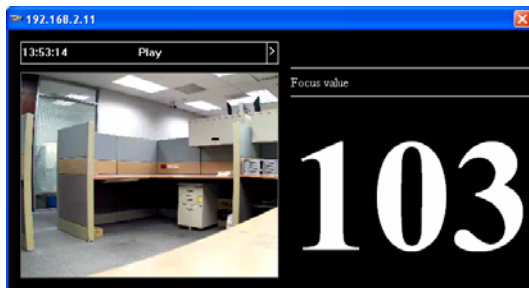

5. For IK10+ models (**GV-VD120D / 121D / 220D / 221D / 320D / 321D / 1500 / 2400 / 3400 / 1530 / 2430 / 2530 / 3430**), hold the supplied Focus Adjustment Cap over the camera view. For details, see [19.3.1 Using Focus Adjustment Cap](#) in the *Quick Start Guide* for details.

6. For **Target Mini Fixed Dome** and **Target Mini Fixed Rugged Dome**, hold the camera cover close to the lens and use the supplied focus adjustment tool for precise focus adjustment.



7. For **Mini Fixed Dome** and **Mini Fixed Rugged Dome**, hold the camera cover close to the lens for precise focus adjustment.
8. Adjust the **Zoom Screw** and the **Focus Screw** of the camera slowly until the focus value reaches the maximum.

**Note:**

1. For locations of adjustment screws and rings in each model, see *Locations of Adjustment Screws*, section, *Getting Started* Chapter, *GV-IPCAM Firmware Manual* on the Software DVD.
2. Do not over tighten the screws. The screws only need to be as tight as your fingers can get them to be. Do not bother using any tool to get them tighter. Doing so can damage the structure of lens.
3. The maximum focus value may vary when the environment changes.

### 24.3.1 Using Focus Adjustment Cap

There are two types of Focus Adjustment Caps for **GV-VD120D / 121D / 220D / 221D / 320D / 321D / 1500 / 2400 / 3400 / 1530 / 2430 / 2530 / 3430**.

#### Focus Adjustment Cap Type I:



Hold the Focus Adjustment Cap on top of the camera view, keep it close to the lens and slightly tilt to one side to adjust the image.

#### Focus Adjustment Cap Type II:



Hold the Focus Adjustment Cap on top of the camera view and keep it close to the camera.



Do not leave a distance between the Focus Adjustment Cap and the camera.

## 25. The Web Interface

### Live View

In this section you can see and configure the default camera view.

Live View Configuration

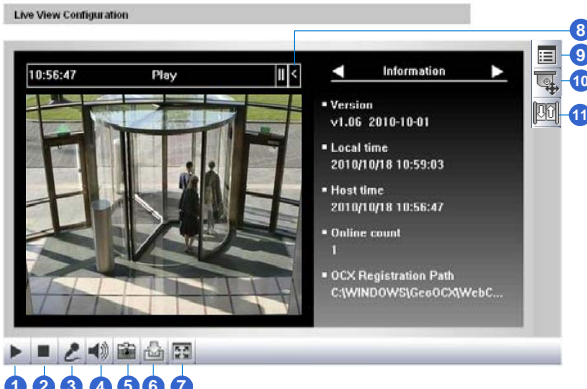

- 8
- 9
- 10
- 11

10:56:47 Play

Information

- Version  
v1.06 2010-10-01
- Local time  
2010/10/18 10:59:03
- Host time  
2010/10/18 10:56:47
- Online count  
1
- OCX Registration Path  
C:\WINDOWS\GeoOCX\WebC...

1 2 3 4 5 6 7

### Live View

In this section you can see and configure the default camera view.

Live View Configuration



10:56:47 Play

Information

- Version  
v1.06 2010-10-01
- Local time  
2010/10/18 10:59:03
- Host time  
2010/10/18 10:56:47
- Online count  
1
- OCX Registration Path  
C:\WINDOWS\GeoOCX\WebC...

12 13



No.	Name	Function
1	Play	Plays live video.
2	Stop	Stops playing video.
3	Microphone	Broadcasts to the surveillance site from a remote PC. Note this function is not available for <b>Ultra Bullet Camera</b> and <b>Target Series</b> . For <b>Cube Camera</b> and <b>Advanced Cube Camera</b> , click the <b>Push to talk</b> button (from the pop-up menu) for the camera to switch between audio transmission and reception, where only one party can speak at a time.
4	Speaker	Transfers sounds of the surveillance site to a remote PC. Note this function is not available for, <b>Mini Fixed Rugged Dome</b> , <b>Ultra Bullet Camera</b> , <b>Target Bullet Camera</b> , and <b>Target Mini Fixed Rugged Dome</b> .
5	Snapshot	Takes a snapshot of live video.
6	File Save	Records live video to the local computer.
7	Full Screen	Switches to full screen view. Right-click the image to see additional options.
8	Control Panel	Displays the camera information, video settings, audio data rate, I/O device status, images captured upon alarm, and GPS location of the camera. Also allows you to adjust image quality and install the program from the hard drive.
9	Show System Menu	Brings up these functions: Alarm Notify, Video and Audio Configuration, Remote Config, Show Camera Name and Image Enhance.

No.	Name	Function
10	PTZ Control Panel	Enables the PTZ Control Panel or the Visual PTZ. Note this function is supported by <b>PTZ Camera</b> and <b>PT Camera</b> , and only partially supported by <b>GV-IP Cameras with motorized varifocal lens</b> .
11	I/O Control	Enables the I/O Control Panel and Visual Automation. Note this function is not available in <b>Mini Fixed Dome, Mini Fixed Rugged Dome, Cube Camera, Advanced Cube Camera</b> and <b>Target Series</b> .
12	LED Control	Click to turn the Alarm LED on and/or adjust the brightness sensitivity. Note this function is only available for <b>Advanced Cube Camera</b> .
13	Alarm Speaker	Click to sound the alarm and/or adjust its volume. To sound the alarm upon motion or tampering events, see <i>Speaker</i> section, <i>Administrator Mode Chapter, GV-IPCAM Firmware Manual</i> on the Software DVD. Note this function is only available for <b>Advanced Cube Camera</b> .

## 26. Upgrading System Firmware

GeoVision periodically releases updated firmware on the website. The new firmware can be simply loaded into the GV-IPCAM by using the Web interface or IP Device Utility included in the software DVD.

### IMPORTANT:

1. To update the camera firmware from versions earlier than V2.07 to the latest version, **back up the files in the storage device to another device** before the upgrade.
2. While the firmware is being updated,
  - A) the power supply must not be interrupted, and
  - B) do not unplug the Ethernet cable if the cable is the source of power supply (Power over Ethernet or PoE supported).
3. Do not turn the power off within 10 minutes after the firmware is updated.
4. If you use the IP Device Utility for firmware upgrade, the computer used to upgrade firmware must be under the same network of the camera.
5. Since the firmware adopts different storage format from V2.07 onward, be sure to re-format the storage device after firmware upgrade. If you have not done so, this warning message appears when you view the Monitoring or Storage Settings' Web interface:

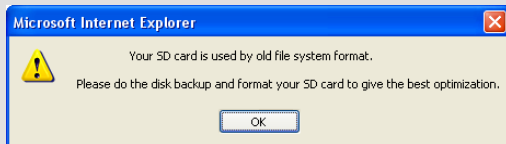

1. Stop these operations: monitoring of IPCam H.264, connection to GV-System and remote connections to Center V2, Vital Sign Monitor, ViewLog Server and 3GPP/RTSP.
2. In the Live View window, click the **Show System Menu** button and select **Remote Config**. This dialog box appears.

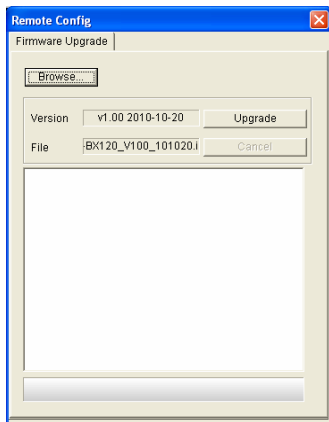

3. Click the **Browse** button to locate the firmware file (.img) saved at your local computer.
4. Click the **Upgrade** button to start the upgrade.

**WARNING:** The interruption of power supply during updating causes not only update failures but also damages to the camera. In this case, please contact your sales representative and send your device back to GeoVision for repair.

## 27. Restoring to Default Settings

You can restore factory default settings through the Web interface or directly on the camera.

### 27.1 Using the Web Interface

1. On the left menu of Web interface, select **Management** and select **Tools**. The Additional Tools dialog box appears.
2. Click the **Load Default** button in the System Settings section.

The screenshot shows the 'Additional Tools' web interface. On the left is a navigation menu with 'Management' expanded to show 'Tools'. The main content area is titled 'Additional Tools' and contains several sections: 'Host Settings' (with a text input for 'Host Name' containing 'GV-EX1200' and an 'Apply' button), 'Firmware Update' (with a text input for 'v1.01 2010-12-03'), 'System Settings' (with a 'Restore to factory default settings' label and a red-bordered 'Load Default' button), and 'Reboot' (with a 'Do you wish to reboot now?' label and a 'Reboot' button). The 'Current chipset temperature inside camera is 48.5 °C (119.3 °F)' is also visible.

## 27.2 Directly on the Camera

### Box Camera

1. Keep the power and network cables connected to the camera.
2. Use a pin to press and hold the **default** button for about 8 seconds on the back panel of the camera.



3. Release the **default** button when the **status LED** blinks.



4. When the **status LED** fades, the process of loading default settings is completed and the camera reboots automatically.

## Ultra Box Camera and Target Box Camera

Press and hold the **default** button on the back panel of the camera for about 8 seconds. Release the **default** button when the **status LED** blinks. For details, see Box Camera, *27.2 Directly on the Camera*.

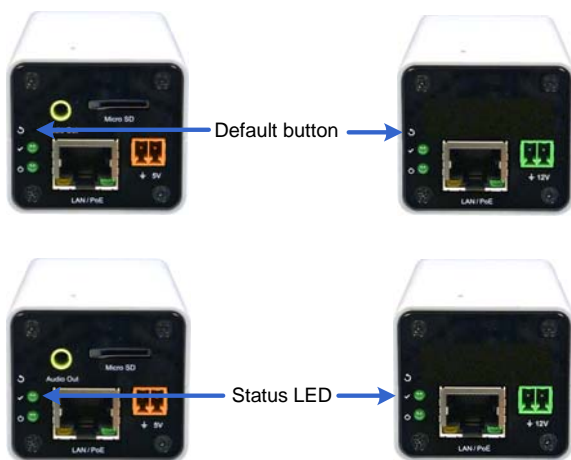

## Mini Fixed Dome

Press and hold the **default** button for about 8 seconds. Release the **default** button when the **status LED** blinks. For details, see Box Camera, 27.2 *Directly on the Camera*.

- GV-MFD120 / 130 / 320



- GV-MFD1501 Series / 2401 Series / 3401 Series / 5301 Series





## Mini Fixed Rugged Dome

Press and hold the **default** button for about 8 seconds. Release the **default** button when the **status LED** blinks. For details, see Box Camera, 27.2 *Directly on the Camera*.

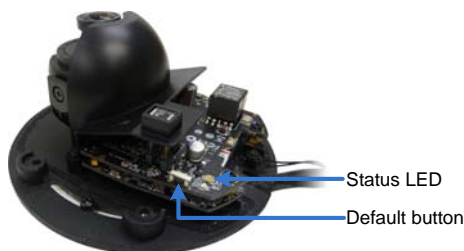

## IR Arctic Box Camera

Note the following procedure is only applicable to GV-BX2510-E / 5310-E. To restore default settings of other IR Arctic Box Cameras, access the load default function from its Web interface. For details, see *Tools, Administrator Mode*, Chapter 4, *GV-IPCam Firmware Manual*.

Press and hold the **default** button for about 8 seconds. Release the **default** button when the **status LED** blinks. For details, see Box Camera, 27.2 *Directly on the Camera*.

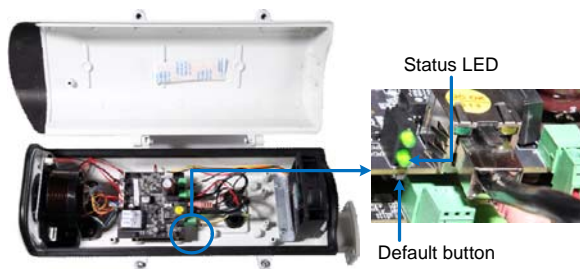

## Target Mini Fixed Target Mini Fixed Rugged Dome

Press and hold the **default** button for about 8 seconds. Release the **default** button when the **status LED** blinks. For details, see Box Camera, 27.2 *Directly on the Camera*.



## Bullet Camera

Press and hold the **default** button. Release the **default** button when the **status LED** blinks. For details, see Box Camera, 27.2 *Directly on the Camera*.

- For GV-BL3700 / 5700, hold the button for 5 seconds. The ready LED blinks.

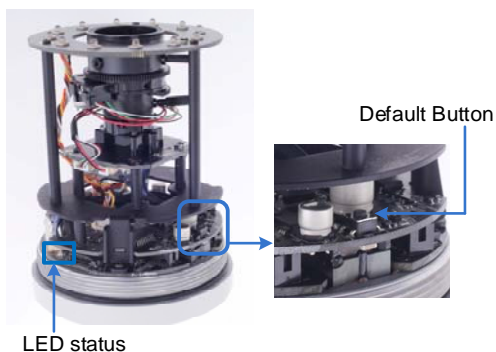

- For the other bullet camera, hold the button for 8 seconds.

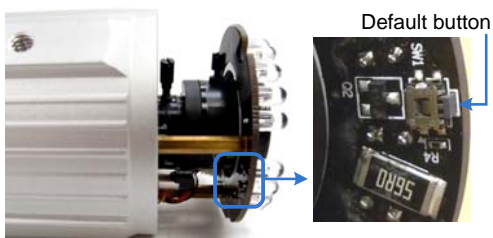

## Ultra Bullet Camera

Press and hold the **default** button for about 8 seconds to restore the default settings. For details, see Box Camera, 27.2 *Directly on the Camera*.

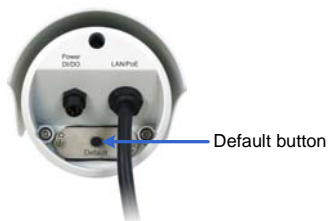

## Target Bullet Camera

Press and hold the **default** button for about 8 seconds to restore the default settings. For details, see Box Camera, 27.2 *Directly on the Camera*.

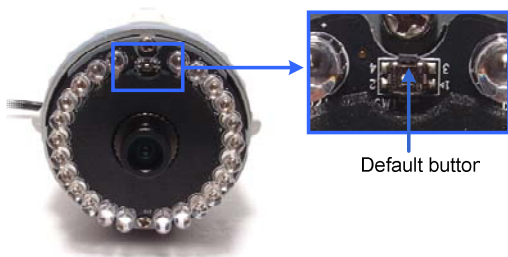

## Vandal Proof IP Dome

Press and hold the **default** button. Release the **default** button when the **status LED** blinks. For details, see Box Camera, 27.2 *Directly on the Camera*.

- For GV-VD3700 / 5700, hold the default button for 5 seconds. Note the camera model doesn't have the LED.



- For the others, hold the button for 8 seconds. The **status LED** blinks.

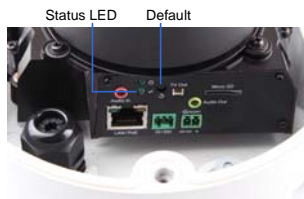

## Target Vandal Proof IP Dome

Press and hold the **default** button for about 8 seconds. Release the **default** button when the **status LED** blinks. For details, see Box Camera, 27.2 *Directly on the Camera.*

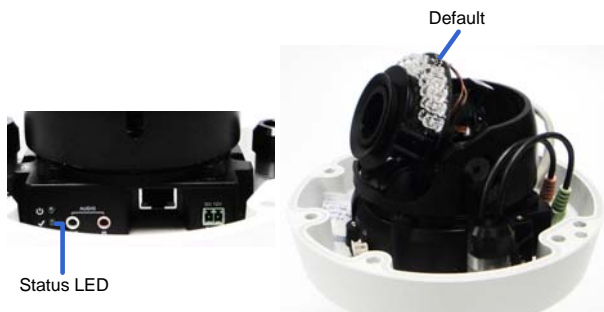

## Fixed IP Dome

Press and hold the **default** button for about 8 seconds. Release the **default** button when the **status LED** blinks. For details, see Box Camera, 27.2 *Directly on the Camera.*



## Target Fixed IP Dome

Press and hold the **default** button for about 8 seconds. Release the **default** button when the **status LED** blinks. For details, see Box Camera, 27.2 *Directly on the Camera*.



## Cube Camera

Press and hold the **default** button for about 8 seconds. Release the **default** button when the **status LED** blinks. The status LED turns **orange** when the camera is ready to use. For details, see Box Camera, 27.2 *Directly on the Camera*.

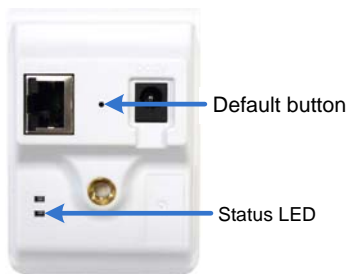

## Advanced Cube Camera

Press and hold the **default** button for about 8 seconds. Release the **default** button when the **status LED** blinks. The status LED turns **green** when the camera is ready to use. For details, see *Box Camera, 27.2 Directly on the Camera*.

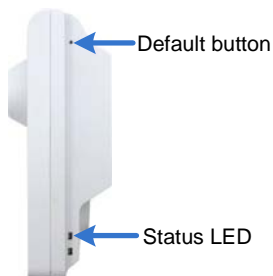

## PT Camera

Press and hold the **default** button for about 8 seconds. Release the **default** button when the **status LED** blinks. The status LED turns **orange** when the camera is ready to use. For details, see *Box Camera, 27.2 Directly on the Camera*.





## Pinhole Camera

Press and hold the **default** button for about 8 seconds. Release the **default** button when the **status LED** blinks. For details, see Box Camera, 27.2 *Directly on the Camera*.

